

Caring People. Improving Lives

Listino prezzi
2024

 acteon



our vision our mission

We believe healthcare is first and foremost about quality of life. Medical treatments are more than just procedures, they restore health, comfort, confidence and happiness and improves life of millions of patients every year. Our vision is to pave the way of a more human-centered healthcare industry based on proactive lifetime care.

To remain at the top of their game and focus on what matters most, healthcare professionals trust integrated solutions that empower them and improve their practices on a daily basis. We provide comprehensive, intuitive workflow solutions that put technology at the service of people and help healthcare professionals restore patients' health effectively, efficiently, and economically.





About Prophylaxis workflow

This combination of solutions helps dentists easily prevent and diagnose potential dental problems such as periodontal disease and tooth decay. It also allows to perform safe and minimally invasive procedures, providing best care and comfort for patients.



Diagnosis

To ensure a reliable diagnosis, I need to get a quick and clear view of initial signs of caries, periodontal disease, and other conditions.

C50



C50 intraoral camera is the perfect companion for non-invasive and reliable caries detection, thanks to its fluorescent technology.



Treatment

I wish to carry out fast and accurate treatment, while reducing hand fatigue.

newtron



Newtron® P5XS B.LED and Bliss™ is the perfect combo to preserve tissues with efficacy and precision. Less force is needed for more comfort.



Air polishing

It is important for me to control the progression of the disease, without neglecting the comfort of my patient.

air-n-go easy



With Air-N-Go® easy, provide a gentle and effective treatment that limits bleeding. Stains and bacterial plaque are removed even in hard-to-reach areas.



Follow-up

In order to educate my patients for better treatment acceptance, I need to highlight the results of my dental care.

C50



C50 provides a reliable and immediate check of the clinical condition. The images can be shown to the patient and saved to his file.



Protection

I need to ensure optimal clinical protection for my patients and limit the risk of cross-contamination.



riskontrol

Riskontrol® disposable tips are your must-have solution to perform dental care in a safe and clean place. It assures protection, comfort and safety in every daily clinical procedures.

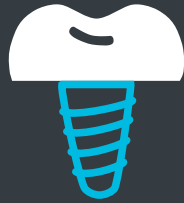

About Implantology workflow

ACTEON®'s implantology workflow leverages its expertise in different areas of the dental care pathway to help practitioners address some of the challenges associated with implantology to facilitate treatment, reduce treatment costs, increase surgical success, reduce chair time and improve the patient experience.

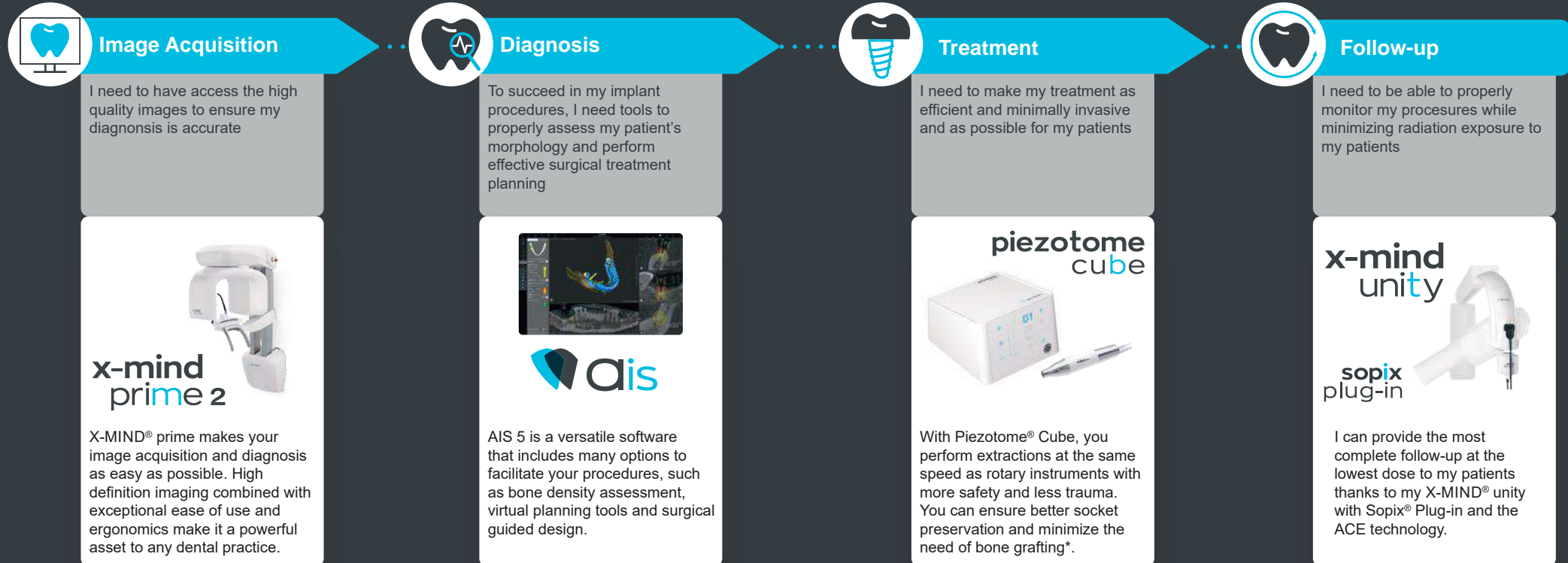

* Troedhan A, Kurrek A, Wainwright M. Ultrasonic Piezotome surgery: it is a benefit for our patients and does it extend surgery time? A retrospective comparative study on the removal of 100 impacted mandibular 3rd molars. Open Journal of Stomatology. 2011;1:179-184



About Digital Prosthesis workflow

ACTEON® digital prosthesis workflow allows practitioners to create effectively both functional and aesthetic smile, and to ensure patients' satisfaction. When it comes to complete prosthetic procedures, our top-of-the-range and innovative products help dentists to perform precise and predictable procedures while delivering the best patients' treatment experience.



Diagnosis

I need to have access to the high quality images to ensure a reliable diagnosis.



x-mind prime 2

X-MIND® prime makes your diagnosis as easy as possible. High definition imaging combined with exceptional ease of use and ergonomics make it a powerful asset to any dental practice.



Preparation & Treatment

I need to make my preparation and treatment as efficient and minimally invasive as possible for my patients.



expasyl exact

Achieve a perfect painless preparation and treatment for your patient with facilitated emergence profile access thanks to Expasyl™ Exact and dedicated Perfect Margin™ ultrasonics tips.



Data Acquisition

I need to capture accurate data to obtain clinically precise prosthesis.



MEDIT

Intra-oral scanner produces realistic images which are high in resolution and rich in details for easy identification of margin lines and undercuts.



Follow-up

I need to highlight the results of my dental care.



C50

The C50 with AIS give patients a clear view of their condition, enabling them to understand the diagnosis and treatment proposals of their dental professional.



Protection

I need to ensure optimal clinical protection for my patients and limit the risk of cross-contamination.



riskontrol

Riskontrol® disposable tips are your must-have solution to perform dental care in a safe and clean place. It assures protection, comfort and safety in every daily clinical procedures.



CONTENTS

ACTEON® Imaging

ACTEON® Equipment

ACTEON® Manual instrumentation

ACTEON® Consumables



ACTEON® IMAGING

EXTRA-ORAL RADIOLOGY

INTRA-ORAL RADIOLOGY

COLOR IMAGERY

EXTRA ORAL RADIOLOGY

.....

ACTEON® imaging



EASY IS THE NEW SMART!



- ✔ Easy 2D diagnosis
- ✔ Easy patient positioning
- ✔ Easy user interface
- ✔ Easy installation
- ✔ Easy to use

x-mind prime 2



RELY ON A COMPLETE SET OF PANORAMIC EXAMS

X-MIND® prime offers a full set of panoramic exams for both adult and child, tailored to meet all your clinical applications:

- Panoramic
- Examination of the temporomandibular joints
- Examination of the maxillary sinuses
- Half-panoramic
- Improved orthogonal panoramic
- Detailed frontal dentition
- Low-dose panoramic
- Bite-wing

POSITION EASILY AND EFFICIENTLY YOUR PATIENT

Natural face-to-face positioning supported by alignment lasers for correct patient positioning.

X-MIND® prime is based on a fix & lift principle. Whether sitting or standing at any height, the telescopic columns can be directly adjusted using the control panel.

Its open space configuration suits all types of patients and is easily accessible for wheelchair users, thanks to its zero footprint design.



SIMPLE CONTROL PANEL

The simplified control panel, smartly located below the chin support, provides a streamlined and precise patient positioning.

Benefit from an error-free patient positioning thanks to the automated chin rest support recognition.



THE BRAND VERSION WITH CEPHALOMETRIC ARM

Easy, reliable and safe mobile sensor handling
CEPHALOMETRIC RADIOGRAPHY

With the ACTEON® cephalometric solution entering the X-MIND® prime range, you can now extend the fields of application of the device to orthodontic analysis, improving diagnosis and treatment planning.

2 AVAILABLE CONFIGURATIONS:

- ✔ X-MIND® prime PAN CEPH
- ✔ X-MIND® prime PAN 3D CEPH

X-MIND® prime Pan 2D



Orthopantomograph (OPG), 110V–240V, with one CCD Pan 2D sensor for panoramic imaging.

- 24 adult and child panoramic programs
- Innovative wall-mounted system
- Face-to-face positioning
- Lightest unit on the market
- Installation under an hour by one single technician

ACTEON® maging Suite (AIS) streamlines any clinical workflow from patient data management to images acquisition. AIS 2DApp with its clean interface simplifies the diagnostic phase and allows a better communication with the patient with its portable viewer and dedicated image filters. All Acteon imaging devices can be integrated in the same AIS environment. Installation and user e-manuals, 2 years standard warranty. Not included: light.

Class IIb medical devices (IMQ) - CE0051
Manufacturer: de Götzen ACTEON® Group - Italy

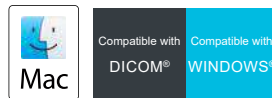

2D Wall-mounted version 110–240V

W1200001

X-MIND® prime Pan 2D CEPH



Orthopantomograph (OPG), 110-240V with single mobile CMOS sensor for panoramic and cephalometric imaging.

Lightweight and compact installation
39 adult and child acquisition programs
Accurate and reliable patient positioning
Fast and easy installation

ACTEON® Imaging Suite (AIS) streamlines any clinical workflow from patient data management to images acquisition. AIS 2DApp with its clean interface simplifies the diagnostic phase and allows a better communication with the patient with its portable viewer and dedicated image filters. All Acteon imaging devices can be integrated in the same AIS environment. Installation and user e-manuals, 2 years standard warranty. Not included: light.

Class IIb medical devices (IMQ) - CE0051
Manufacturer: de Götzen ACTEON® Group - Italy

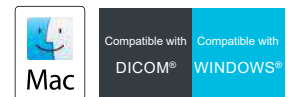

2D version 110-240V

W1200009

2D version Double sensor 110-240V

W1200009.DS

X-MIND® prime Pan 3D



Orthopantomograph (OPG), 110V–240V,
with one CMOS sensor used for Pan and 3D.

- 54 adult and child 2D and 3D programs
- Delivered with AIS 3D app and powerful treatment planning tools
- 4 FOV : 50x50, 85x50, 85x93 and 120x100 mm
- Innovative wall-mounted system
- Face-to-face positioning
- Lightest unit on the market
- Installation under an hour by one single technician

ACTEON® Imaging Suite (AIS) Software, for visualization and analysis of 2D and 3D acquisitions and treatment planning. Includes five licenses for 3D app standard, the 3D viewer and implant planning application. Compatible with all 2D and 3D imaging products of the group. Installation and user e-manuals, 2 years standard warranty. Not included: Light.

Class IIb medical devices (IMQ) - CE0051
Manufacturer: de Götzen ACTEON® Group - Italy



3D Wall-mounted version 110–240V + WS + Monitor

W1200005

X-MIND® prime Pan 3D CEPH



Orthopantomograph (OPG), 110-240V equipped
with a CMOS PAN/3D panel and a CMOS 2D CEPH
sensor.

69 adult and child 2D PAN/CEPH and 3D programs
Delivered with AIS 3D app and powerful treatment
planning tools
5 FOV : 50x50, 85x50, 85x93 and 120x100 mm
Accurate and reliable patient positioning
Fast and easy installation
Software preinstalled.

ACTEON® Imaging Suite (AIS) Software, for
visualization and analysis of 2D and 3D acquisitions
and treatment planning. Includes five licenses for 3D
app standard, the 3D viewer and implant planning
application. Compatible with all 2D and 3D imaging
products of the group. Installation and user e-manuals,
2 years standard warranty. Not included: Light.

Class IIb medical devices (IMQ) - CE0051
Manufacturer: de Götzen ACTEON® Group - Italy

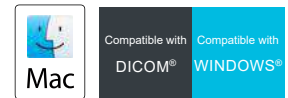

3D version 110-240V + WS + Monitor

W1200010

Spare parts



Self-standing base *W1200100*

Column *W1200101*

XMP 2D PC

Windows 10, 64 bits. Nvidia Graphic card.
no included: network card, monitor, AIS 3D App

4695489200

XMP 3D WORKSTATION

Windows 10, 64 bits. Nvidia Graphic card, 1 Gbit Ethernet Network card.
AIS 3D APP.
not included: monitor

6604900100

22" MONITOR

DELL P2219H 22" monitor

4695454900

Ethernet board dual port

4695488300

Chin rests maxillary sinus

6604011605

Full 2D and 3D panoramic chin rest

6604012000

Chin rest for edentulous

5407098100

TMJ support

6604011800

Temple bar left 2D, 3D & CEPH

6101010212

Temple bar right 2D, 3D & CEPH

6101010112

Pan centering bites x50

6607090100

Disposable bite protective sleeves x100

6607110700

Double ceph sensor upgrade kit

W1205009.DS



x-mind trium

true low dose

- 3 in 1 System covering Pan, 3D and Ceph exams
- 3D Mapping of bone density
- 4 FOV: From 4x4 to 11x9
- Up to 50% Dose reduction*
- 75 µm High-resolution image



FOCUS ON THE REGION OF INTEREST

X-MIND® trium offers you a broad selection of field of view, letting you focus on the region of interest for the target diagnosis and reducing the patient's exposure to X-rays:



ø 110x90 mm



ø 80x90 mm



ø 60x60 mm



ø 40x40 mm

* Ratio based on DAP measurements from standard X-MIND® Trium settings 90kV-8mA-300prjs

DOSE REDUCTION WITHOUT COMPROMISES IN IMAGE QUALITY

Up to 50%* dose reduction with TRUE LOW DOSE CBCT

True low dose helps to reduce the X-ray dose while preserving a high image quality. The unique True Low Dose solution is possible thanks to:

IMAGE ENHANCING ALGORITHM

With the new powerful algorithm, you can now decrease the X-ray settings (up to 50%) with peace of mind. Our Low Dose functionality on the 3D radiographic scan will reveal the same anatomical structures of the X-MIND® trium exam performed with the standard dose.

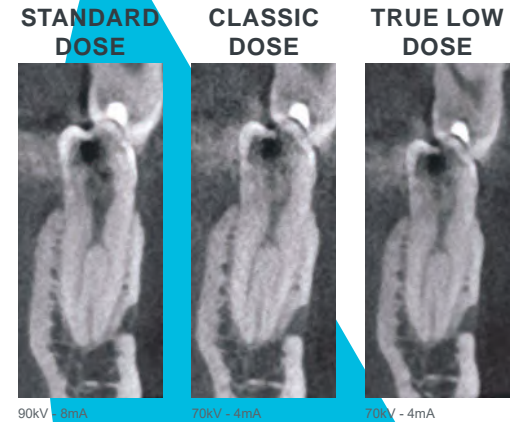

SMART SLIDE MOVEMENT

X-MIND® trium sensor cassette is sliding closer to the child's head during the exam. This allows to reduce the X-ray dose settings while keeping the exact same image quality as before.

BEFORE SLIDE MOVEMENT



AFTER SLIDE MOVEMENT



AN OUTSTANDING IMAGE QUALITY

The quality of the diagnosis and endodontic treatments improves significantly with the 75 µm resolution of X-MIND® trium.

X-MIND® trium TLD Pan 3D



OrthoPanTomograph (OPG), 115-220V, with Flat Panel Detector for CBCT and panoramic imaging.

- Child-dedicated Panoramic and CBCT programs
- Low dose CBCT programs
- Improved Orthogonality
- TMJ section
- Maxillary Sinus exam
- CBCT FOV Ø40x40, Ø60x60, Ø80x90, Ø110x90

Software preinstalled on the provided workstation and monitor.

ACTEON® Imaging Suite (AIS) Software, for visualisation and analysis of 2D and 3D acquisitions and treatment planning. Includes five licenses for 3D app PRO, the 3D viewer and implant planning application.

Compatible with all 2D and 3D imaging products of the group. Installation and user e-manuals, 2 years standard warranty. Not included: Light.

* The control panel can be placed on the right during installation according to the practitioner's needs

Class IIb medical devices (IMQ) - CE0051
Manufacturer: de Götzen ACTEON® Group - Italy

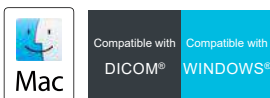

Control panel on the left*

W0920010

Warranty extensions

Warranty extension for 1 additional year	W0900028
Warranty extension for 2 additional years	W0900029
Warranty extension for 3 additional years	W0900030

X-MIND® trium TLD Pan 3D CEPH



OrthoPanTomograph (OPG), 115-220V, with one CMOS 2D sensor for cephalometry and a flat Panel Detector for CBCT and panoramic imaging.

- Child-dedicated Panoramic and CBCT programs
- Low dose CBCT programs
- Improved Orthogonality
- TMJ section
- Maxillary Sinus exam
- Cephalometric exams
- CBCT FOV Ø40x40, Ø60x60, Ø80x90, Ø110x90

Software preinstalled on the provided workstation and monitor.

ACTEON® Imaging Suite (AIS) Software, for visualisation and analysis of 2D and 3D acquisitions and treatment planning. Includes five licenses for 3D app PRO, the 3D viewer and implant planning application.

Compatible with all 2D and 3D imaging products of the group. Installation and user e-manuals, 2 years standard warranty. Not included: Light.

* The control panel can be placed on the right during installation according to the practitioner's needs

Class IIb medical devices (IMQ) - CE0051
Manufacturer: de Götzen ACTEON® Group - Italy

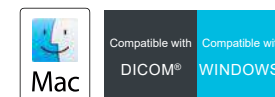

CEPH right, control panel on the left*

W0920012

CEPH left, control panel on the left*

W0920233

Warranty extensions

Warranty extension for 1 additional year	W0900031
Warranty extension for 2 additional years	W0900032
Warranty extension for 3 additional years	W0900033

Accessories & spare parts

Pan 2D sensor for OrthoPanTomograph (OPG) (to add a second 2D sensor or for replacement)	<i>W0900036</i>
Ceph 2D sensor for OrthoPanTomograph (OPG) and cephalometry (for replacement)	<i>W0900037</i>
CBCT PLAN sensor for 3D imaging (for replacement)	<i>W0900038</i>
PC Client (no monitor) not included: network card, Monitor, AIS 3D App	<i>W0900040</i>
PC workstation 3D (no monitor) Windows 10, Nvidia graphic card, 1 Gbit Ethernet Network card. not included: monitor	<i>W0900042</i>
PC Workstation 2D Windows 10, monitor network card	<i>W0900246</i>
Upgrade kit for dell 3620 WORKSTATION 1Tb SSD Hard drive - 16Gb RAM - P620 Nvidia GPU (display card)	<i>W0900277</i>
27" Monitor Lenovo P27H-10 27" monitor	<i>W0900141</i>
Remote trigger & 15m cable	<i>W0900091</i>
Ears protections X-MIND® trium (280 pcs) only for arms Ceph	<i>W0900110</i>
Chin rests, bite block, TMJ X-MIND® trium	<i>W0900080</i>
Temple bars left/right X-MIND® trium	<i>W0900071</i>
Sliding bite blocks X-MIND® trium (10 pcs)	<i>W0900142</i>
Bite protections X-MIND® trium (500 pcs)	<i>W0900113</i>



X-MIND® TRIUM Self Standing Base

W0900236





AIS 3D App 5.0

AIS 3D APP 5.0 Start	W1000023
AIS 3D APP 5.0 Pro	W1000024
AIS 3D APP 5.0 Design 1 year license, for the first year	W1000025
AIS 3D APP 5.0 Design 1 year license, starting the second year	W1000026

ACTEON® Imaging Suite - DICOM Licence

Licence AIS DICOM package	W0900153
----------------------------------	-----------------



INTRA ORAL RADIOLOGY

.....

ACTEON® imaging



x-mind unity

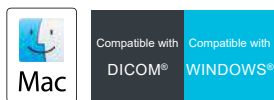

- 0.4 mm focal spot
- Configurable radiological settings (time, mA, kV)
- Ace – Reducing patient dose
- Dosage display
- Top and bottom mounting

X-MIND® unity is pre-wired for the integration of the SOPIX® Plug-in / SOPIX² Plug-in digital sensor.

X-MIND® unity is Delivered with a long cone in standard version.

X-MIND® unity - Mobile



Package including mobile support and X-MIND® unity for mobile support

Mobile support for X-MIND® unity	3.457,80 €	W0800127
X-MIND® unity for mobile support:		+
Mobile support - Long cone		W0800085
Mobile support - Short cone		W0800091
Mobile support - Long square cone		W0800128
Mobile support - Short square cone		W0800129

X-MIND® unity - Top mounting

Short cone - extensor 0.40m	3.128,50 €	W0800000
Short cone - extensor 0.80m	3.128,50 €	W0800001
Short cone - extensor 1.10m	3.128,50 €	W0800002
Long cone - extensor 0.40m	3.128,50 €	W0800003
Long cone - extensor 0.80m	3.128,50 €	W0800004
Long cone - extensor 1.10m	3.128,50 €	W0800005
Short square cone - extensor 0.40m	3.128,50 €	W0800102
Short square cone - extensor 0.80m	3.128,50 €	W0800103
Short square cone - extensor 1.10m	3.128,50 €	W0800104
Long square cone - extensor 0.40m	3.128,50 €	W0800006
Long square cone - extensor 0.80m	3.128,50 €	W0800007
Long square cone - extensor 1.10m	3.128,50 €	W0800008

X-MIND® unity - Bottom mounting

Short cone - extensor 0.40m	3.128,50 €	W0800009
Short cone - extensor 0.80m	3.128,50 €	W0800010
Short cone - extensor 1.10m	3.128,50 €	W0800011
Long cone - extensor 0.40m	3.128,50 €	W0800012
Long cone - extensor 0.80m	3.128,50 €	W0800013
Long cone - extensor 1.10m	3.128,50 €	W0800014
Short square cone - extensor 0.40m	3.128,50 €	W0800105
Short square cone - extensor 0.80m	3.128,50 €	W0800106
Short square cone - extensor 1.10m	3.128,50 €	W0800107
Long square cone - extensor 0.40m	3.128,50 €	W0800015
Long square cone - extensor 0.80m	3.128,50 €	W0800016
Long square cone - extensor 1.10m	3.128,50 €	W0800017

Accessories & spare parts



X-MIND® unity short cone 90,00 € W0800018



X-MIND® unity long cone 90,00 € W0800019



X-MIND® unity short square cone 90,00 € W0800137



X-MIND® unity long square cone 90,00 € W0800020



X-MIND® unity tubehead 2.172,40 € W0800022



X-MIND® unity timer 1.106,50 € W0800023



IRIX 70 wall plate for X-MIND® unity installation 180 € W0800100

Spare parts

Extensor 0.40m X-MIND® unity top mounting	311,80 €	W0800025
Extensor 0.80m X-MIND® unity top mounting	311,80 €	W0800026
Extensor 1.10m X-MIND® unity top mounting	311,80 €	W0800027
Extensor 0.40m X-MIND® unity bottom mounting	311,80 €	W0800028
Extensor 0.80m X-MIND® unity bottom mounting	311,80 €	W0800029
Extensor 1.10m X-MIND® unity bottom mounting	311,80 €	W0800030
Extensor pantograph X-MIND® unity	1.146,00 €	W0800031

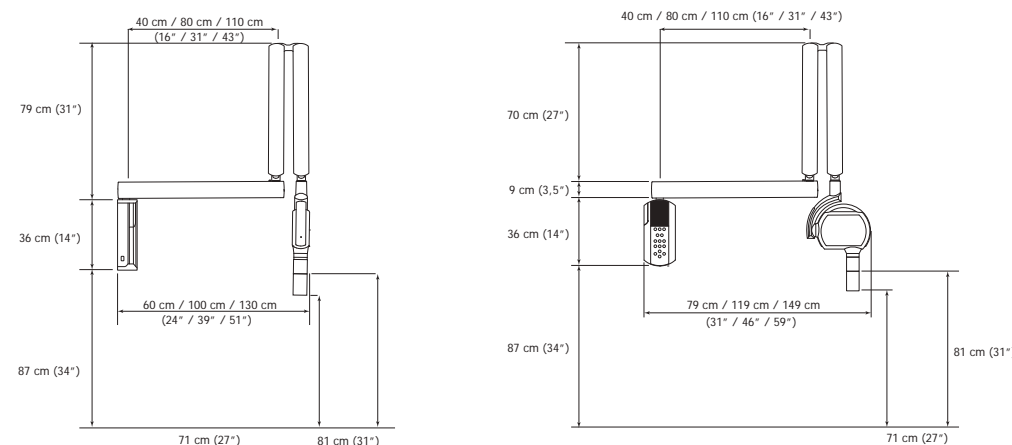
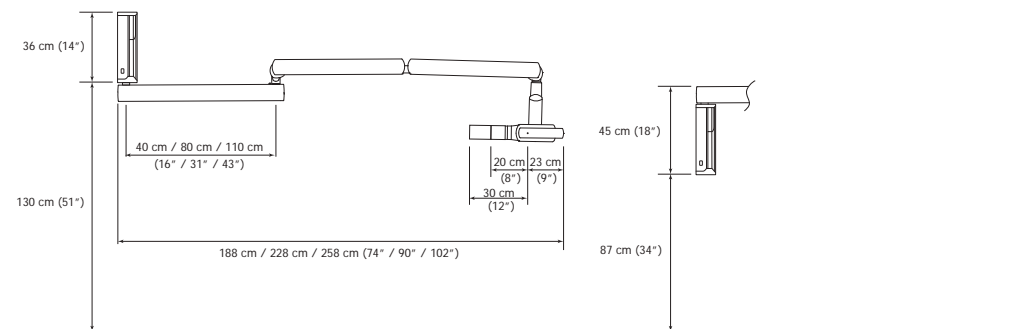

x-mind dc



- ✔ Long lasting high performance
- ✔ Easy-to-use
- ✔ Flexible installation alternatives for more practice
- ✔ Different cones to improve your experience in all your clinical needs

Delivered with a generator 70KV, a pantograph, an extensor and a timer.



X-MIND® DC - Mobile



Mobile support - Long cone	2.925,40 €	5.92.23133
Mobile support - Square cone	2.925,40 €	5.92.23163

Class IIb medical devices (IMQ) - CE0051 Manufacturer: de Götzen ACTEON® Group - Italy

X-MIND® DC - Top mounting

Long cone - extensor 0.40m (max. distance 143cm)	2.588,40 €	5.92.23137
Long cone - extensor 0.80m (max. distance 184cm)	2.588,40 €	5.92.23138
Long cone - extensor 1.10m (max. distance 212cm)	2.588,40 €	5.92.23139
Square cone - extensor 0.40m (max. distance 143cm)	2.588,40 €	5.92.23167
Square cone - extensor 0.80m (max. distance 184cm)	2.588,40 €	5.92.23168
Square cone - extensor 1.10m (max. distance 212cm)	2.588,40 €	5.92.23169

X-MIND® DC - Bottom mounting

Long cone - extensor 0.40m (max. distance 143cm)	2.588,40 €	5.92.23130
Long cone - extensor 0.80m (max. distance 184cm)	2.588,40 €	5.92.23131
Long cone - extensor 1.10m (max. distance 212cm)	2.588,40 €	5.92.23132
Square cone - extensor 0.40m (max. distance 143cm)	2.588,40 €	5.92.23160
Square cone - extensor 0.80m (max. distance 184cm)	2.588,40 €	5.92.23161
Square cone - extensor 1.10m (max. distance 212cm)	2.588,40 €	5.92.23162

X-MIND® DC - Unit

Long cone - mounting extensor 0.40m	2.678,40 €	5.92.23135
--	-------------------	-------------------

X-MIND® DC - Ceiling

Long cone - ceiling mounting extensor 0.40m	2.678,40 €	5.92.23136
--	-------------------	-------------------

(standard Faro column Ø60cm) Ceiling fasteners not included

X-MIND® DC - II UNIT Long cone

Without timer and extensor	2.023,40 €	5.93.23231
-----------------------------------	-------------------	-------------------

Class IIb medical devices (IMQ) - CE0051 Manufacturer: de Götzen ACTEON® Group - Italy

x-mind ac



- ✔ Long lasting high performance
- ✔ Easy-to-use
- ✔ Flexible installation alternatives for more practice
- ✔ Different cones to improve your experience in all your clinical needs

Delivered with a generator 70KV, a pantograph, an extensor and a timer.

X-MIND® AC - Mobile



Mobile support - Long cone	2.543,40 €	5.90.23133
Mobile support - Square cone	2.543,40 €	5.90.23163

Class IIb medical devices (IMQ) - CE0051
Manufacturer: de Götzen ACTEON® Group - Italy

X-MIND® AC - Top mounting

Long cone - extensor 0.40m (max. distance 143cm)	2.173,80 €	5.90.23137
Long cone - extensor 0.80m (max. distance 184cm)	2.173,80 €	5.90.23138
Long cone - extensor 1.10m (max. distance 212cm)	2.173,80 €	5.90.23139
Square cone - extensor 0.40m (max. distance 143cm)	2.173,80 €	5.90.23167
Square cone - extensor 0.80m (max. distance 184cm)	2.173,80 €	5.90.23168
Square cone - extensor 1.10m (max. distance 212cm)	2.173,80 €	5.90.23169

X-MIND® AC - Bottom mounting

Long cone - extensor 0.40m (max. distance 143cm)	2.173,80 €	5.90.23130
Long cone - extensor 0.80m (max. distance 184cm)	2.173,80 €	5.90.23131
Long cone - extensor 1.10m (max. distance 212cm)	2.173,80 €	5.90.23132
Square cone - extensor 0.40m (max. distance 143cm)	2.173,80 €	5.90.23160
Square cone - extensor 0.80m (max. distance 184cm)	2.173,80 €	5.90.23161
Square cone - extensor 1.10m (max. distance 212cm)	2.173,80 €	5.90.23162

X-MIND® AC - Unit

Long cone - mounting extensor 0.40m	2.318,40 €	5.90.23135
--	-------------------	-------------------

X-MIND® AC - Ceiling

Long cone - ceiling mounting extensor 0.40m	2.318,40 €	5.90.23136
--	-------------------	-------------------

(standard Faro column Ø60cm) Ceiling fasteners not included

X-MIND® AC - II UNIT Long cone

Without timer and extensor	1.586,30 €	5.91.23231
-----------------------------------	-------------------	-------------------

Class IIb medical devices (IMQ) - CE0051
Manufacturer: de Götzen ACTEON® Group - Italy

Spare parts

	X-MIND® AC tubehead	1.275,60 €	5.21.23130
	X-MIND® DC tubehead	1.689,40 €	5.31.23130
	X-MIND® AC timer	721,70 €	5.25.23130
	X-MIND® DC timer	721,70 €	5.35.23130
	Short cone (20cm SSD)	83,40 €	29701195
	Long cone (31cm SSD)	98,80 €	29701197
	Square cone (31cm SSD)	92,20 €	29701199.C
	IRIX 70 wall plate for X-MIND® AC or DC installation	199,80 €	22002350
	X-MIND® AC/DC wall plate bottom mounting	129,50 €	29700384.C
	X-MIND® AC/DC wall plate top mounting	129,50 €	29700385.C

Spare parts

	X-MIND® AC pantograph	738,80 €	29700813.C
	X-MIND® DC pantograph	738,80 €	29701006.C
	X-MIND® AC/DC 0.40m extensor bottom mounting	194,80 €	29700380.C
	X-MIND® AC/DC 0.80m extensor bottom mounting	194,80 €	29700378.C
	X-MIND® AC/DC 1.10m extensor bottom mounting	194,80 €	29700379.C
	X-MIND® AC/DC 0.80m extensor with pantograph and wall plate	979,20 €	5.30.00131
	X-MIND® AC/DC 1.10m extensor with pantograph and wall plate	979,20 €	5.30.00132
	X-MIND® AC/DC 0.40m extensor top mounting	194,80 €	29700620.C
	X-MIND® AC/DC 0.80m extensor top mounting	194,80 €	29700621.C
	X-MIND® AC/DC 1.10m extensor top mounting	194,80 €	29700622.C
	X-MIND® AC/DC 0.40m extensor column unit	194,80 €	29700381.C
	X-MIND® AC/DC 0.40m extensor ceiling mounting	194,80 €	29700382.C
	X-MIND® AC/DC UNITY ECB	92,20 €	5.15.00133
	X-MIND® AC/DC UNITY LIGHT 230 V	112,00 €	5.15.00132

Mounting

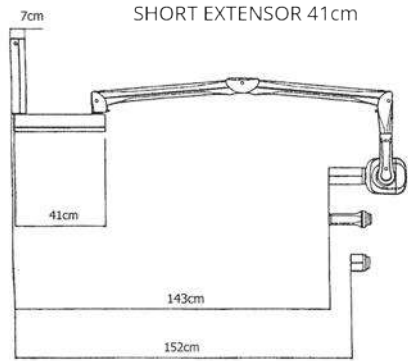

BRACKET 0.41m

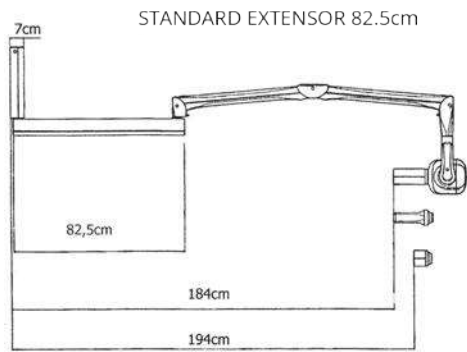

BRACKET 0.825m

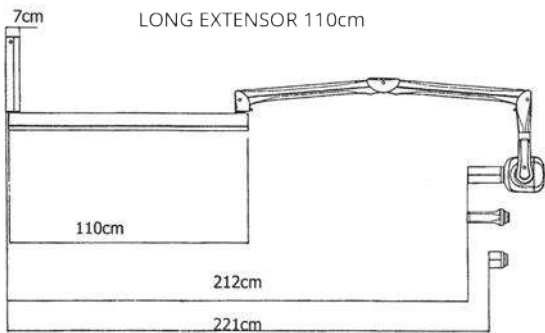

BRACKET 1.10m



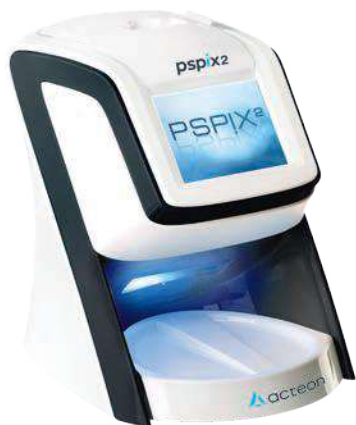

pspix2

- A striking contrast for an accurate diagnosis
- The most compact PSP scanner on the market
- Touchscreen for intuitive indications
- Elegant design fits within your dental office
- Various sizes for more adaptability

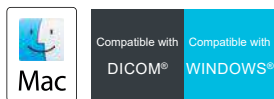

PSPIX®2 - Digital imaging plate system

6.526,00 € S_702_0001

with 4 imaging plates (2x size 1, 2x size 2), 200 bags & covers for imaging plate (100x size 1, 100x size 2), an imaging plate storage box, 1 stylus for touchscreen, 10 samples of Soprowipes, 1 power supply 100-240 VAC, 1 Ethernet cable, [SOPRO Imaging software and its licence](#).

PSPIX®2 - Digital imaging plate system

6.526,00 € S_702_0013

with 4 imaging plates (2x size 1, 2x size 2), 200 bags & covers for imaging plate (100x size 1, 100x size 2), an imaging plate storage box, 1 stylus for touchscreen, 10 samples of Soprowipes, 1 power supply 100-240 VAC, 1 Ethernet cable, [the ACTEON® Imaging Suite \(AIS\) software](#).

	WINDOWS® MINIMUM CONFIGURATION REQUIRED	MAC® MINIMUM CONFIGURATION REQUIRED
Processor	Intel i5 4 cores - 8 threads	Intel i5 4 cores - 8 threads
Hard disk	300 GB	300 GB
RAM	4 GB	4 GB
Graphic card	Compatible OPEN GL 2.1 (suggested an NVIDIA GT/GTX) or alternatively DriectX 9 or 11 Graphic device	Compatible OPEN GL 2.1
Screen resolution	1280 x 1024	1680 x 1050
Network card	100 Mb	100 Mb
Operation system	Windows 10 PRO 64 bits	macOS Catalina (10.15)

Accessories

Standard imaging plate

	PSPIX®2		PSPIX® 1 st generation	
		Set of 2		Set of 6
Size 0 (22 x 35mm)		109,80 € 990215		430,30 € S_700178
Size 1 (24 x 40mm)		109,80 € 990216		430,30 € S_700179
Size 2 (31 x 41mm)		109,80 € 990217		430,30 € S_700180
Size 3 (27 x 54mm)		109,80 € 990218		430,30 € S_700181

PSPIX®2 imaging plate - Class IIa Medical devices (GMED) - CE0459 - Manufacturer: Sopro ACTEON® Group - France
 PSPIX® imaging plate - Class IIa Medical devices (Eurofins) - CE0537 - Manufacturer: Soredex - Distributor: Sopro ACTEON® Group

Accessories

Protective bag for imaging plate

	PSPIX®2 & PSPIX® 1 st generation	
	Set of 250	
Size 0		73,50 € 700342L
Size 1		73,50 € 700343L
Size 2		73,50 € 700344L
Size 3		73,50 € 700345L

Bag & cover for imaging plate



with integrated cardboard envelop

	PSPIX®2		PSPIX® 1 st generation	
	Set of 300		Set of 250	
Size 0		109,80 € 700546		120,70 € 700338L
Size 1		109,80 € 700547		120,70 € 700339L
Size 2		109,80 € 700548		120,70 € 700340L
Size 3		109,80 € 700549		120,70 € 700341L

Accessories

	Bag & cover for imaging plate start up kit (set of 100 pieces of size 1 and 100 pieces of size 2)	75,70 €	700550
	Imaging plate storage box (without imaging plates)	52,70 €	990219
	Stylus for PSPIX®2 touchscreen	7,70 €	005132
	Cleaning plate for PSPIX®2	23,10 €	990243
	Unit Cover for PSPIX®2	31,80 €	990247
	Autoclavable removable parts for PSPIX®2 with 1 removable autoclavable receptacle and 1 autoclavable insertion guide for imaging plates	232,70 €	990241
	Size 4 kit for PSPIX®2 with 1 positioning holder (size 4), 3 imaging plates (size 3) and 100 Hygiene Bag (size 4)	265,60 €	990252
	Plastic holder size 4	17,60 €	990251
	Imaging plates size 3 (Set of 3)	183,30 €	990248
	Protective bag size 4 (Set of 100)	59,30 €	700644

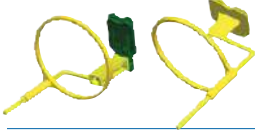
Accessories

	KIT ALIMENTATION PSPIX²	90,00 €	925068 + 107177
	Positioning set for PSPIX^{®2} & PSPIX[®] imaging plate with five positioning holders with ring for bitewing and one centring devices	125,00 €	S_700195
	Positioning set for PSPIX^{®2} & PSPIX[®] imaging plate⁽³⁾ with two positioning holders with ring for anterior teeth, two positioning holders with ring for posterior teeth and two centring devices	185,00 €	S_700196
	ACTEON[®] Imaging Suite⁽⁴⁾ (AIS) USB stick	720,00 €	990317

(1) - PSPIX Imagine plate: Class IIa medical devices (Eurofins) - CE 0537 - Manufacturer: Soredex - Distributor: Sopro ACTEON[®] Group - France

(2) - Class I medical devices - CE - Manufacturer: Sopro ACTEON[®] Group - France

(3) - Class I medical device - CE - Manufacturer: KerrHawe SA - Distributor: Sopro ACTEON[®] Group - France

(4) - Class IIb Medical device (IMQ) - CE0051 - Manufacturer: de Gotzen ACTEON[®] Group - Italy



SMART SENSOR FOR EFFORTLESS PERFORMANCE

sopix
plug-in

sopix 2
plug-in



SMART DOSE

The ACE® technology protects both the image and your patient from unnecessary exposure.

AN EFFICIENT PROTECTION WITH A MINIMAL EXPOSURE TIME

The Automatic Control Exposure® technology analyses in real-time the amount of X-rays accumulated by the sensor.

Once the sensors receive the required radiation dose, it orders the X-mind® unit to limit the emission of X-rays. You take an optimal quality x-ray from the first time avoiding overexposure risk to both the image and the patient.

Thus, even with a too high set-up of your generator, the patient receives the minimum dose required to provide a high-quality image.



SMART TECHNOLOGY

Our latest generation of digital sensors provide a sharp X-ray image for an easy reading of the different dental tissues.

EXPERIENCE THE LATEST GENERATION OF DIGITAL SENSORS

The FIBER2PIXEL® technology is based on the use of wide spectrum optical microfibers, guaranteeing the clarity and the contrast of the images.



SMART FLOW

Our mobile sensors adapt to all clinical cases, all morphologies and all software, to provide you and your patients greater comfort.



sopix² plug-in

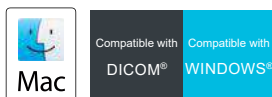
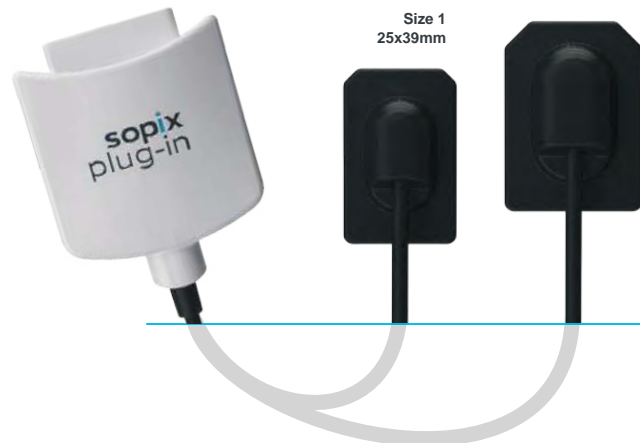

SOPIX® PLUG-IN size 1 with SOPIX® Plug-in dock

3.800,70 € S_K60_1000

SOPIX® PLUG-IN size 2 with SOPIX® Plug-in dock

5.088,20 € S_K60_1001

CMOS sensor with optic fiber of 1.5 million of pixels (size 1) or 2.21 millions of pixels (size 2), theoretical resolution of 25pl/mm, actual resolution > 18pl/mm, 0.70m cable. Includes ACE technology (Automatic Control Exposure).

with a sensor holder, 10 sensor sheaths, the ACTEON® Imaging Suite (AIS) software.

The sensor can be used with Sopix® Plug-in dock.

sopix² plug-in

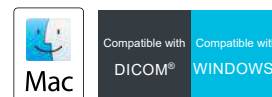
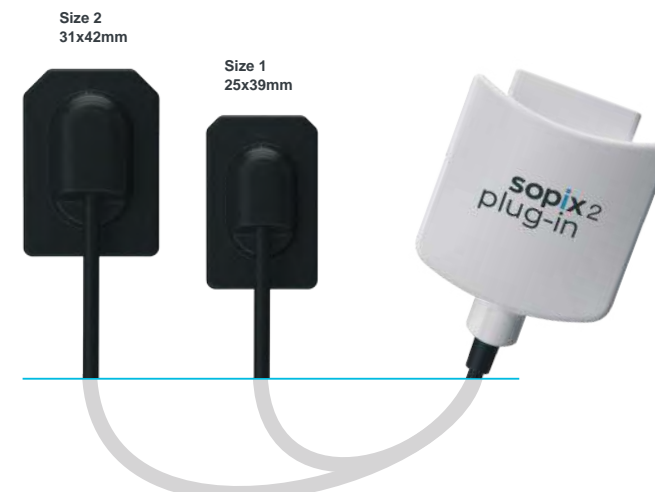

SOPIX®² PLUG-IN size 1 with SOPIX® Plug-in dock

4.264,20 € S_K60_1002

SOPIX®² PLUG-IN size 2 with SOPIX® Plug-in dock

6.468,40 € S_K60_1003

CMOS sensor with optic fiber of 1.5 million of pixels (size 1) or 2.21 millions of pixels (size 2), theoretical resolution of 25pl/mm, actual resolution > 12pl/mm, 0.70m cable. Includes ACE technology (Automatic Control Exposure).

with a sensor holder, 10 sensor sheaths, the ACTEON® Imaging Suite (AIS) software.

The sensor can be used with Sopix® Plug-in dock.

sopix

sopix 2



- Striking contrast thanks to FIBER2PIXEL® technology
- High Quality images
- No more overexposed images with ACE technology
- Rounded edges and corners for better comfort

SOPIX®2



SOPIX®2 USB2 Sensor size 1 high definition	3.657,60 €	S_802_0004
SOPIX®2 USB2 Sensor size 2 high definition	5.159,30 €	S_802_0005

CMOS sensor with optic fiber of 1.5 million of pixels (size 1) or 2.21 millions of pixels (size 2), theoretical resolution of 25pl/mm, actual resolution > 18pl/mm, 3.70m cable. Includes ACE technology (Automatic Control Exposure).

with a sensor holder, 10 sensor sheaths, [SOPRO Imaging software and its licence](#).

SOPIX®2



SOPIX®2 USB2 Sensor size 1 high definition	3.657,60 €	S_802_0008
SOPIX®2 USB2 Sensor size 2 high definition	5.159,30 €	S_802_0009

CMOS sensor with optic fiber of 1.5 million of pixels (size 1) or 2.21 millions of pixels (size 2), theoretical resolution of 25pl/mm, actual resolution > 18pl/mm, 3.70m cable. Includes ACE technology (Automatic Control Exposure).

with a sensor holder, 10 sensor sheaths, [the ACTEON® Imaging Suite \(AIS\) software](#).

	WINDOWS® MINIMUM CONFIGURATION REQUIRED	MAC® MINIMUM CONFIGURATION REQUIRED
Processor	Intel i5 4 cores - 8 threads	Intel i5 4 cores - 8 threads
Hard disk	300 GB	300 GB
RAM	4 GB	4 GB
Graphic card	Compatible OPEN GL 2.1 (suggested an NVIDIA GT/GTX) or alternatively DirectX 9 or 11 Graphic device	Compatible OPEN GL 2.1
Screen resolution	1280 x 1024	1680 x 1050
Network card	100 Mb	100 Mb
Operation system	Windows 10 PRO 64 bits	macOS Catalina (10.15)

SOPIX®



SOPIX® USB2 Sensor size 1 standard definition	2.982,50 €	S_802_3000
SOPIX® USB2 Sensor size 2 standard definition	4.819,00 €	S_802_3001

CMOS sensor with optic fiber of 1.5 million of pixels (size 1) or 2.21 millions of pixels (size 2), theoretical resolution of 25pl/mm, actual resolution > 12pl/mm, 3.70m cable. Includes ACE technology (Automatic Control Exposure).

with a sensor holder, 10 sensor sheaths, [SOPRO Imaging software and its licence](#).

SOPIX®



SOPIX® USB2 Sensor size 1 standard definition	2.982,50 €	S_802_3008
SOPIX® USB2 Sensor size 2 standard definition	4.819,00 €	S_802_3009

CMOS sensor with optic fiber of 1.5 million of pixels (size 1) or 2.21 millions of pixels (size 2), theoretical resolution of 25pl/mm, actual resolution > 12pl/mm, 3.70m cable. Includes ACE technology (Automatic Control Exposure).

with a sensor holder, 10 sensor sheaths, [the ACTEON® Imaging Suite \(AIS\) software](#).

Accessories



Positioning set for SOPIX®2/SOPIX® series sensors

with five positioning holders with ring
(bitewing, anterior, posterior, endo anterior, endo posterior)

321,60 € 700042



SOPIX®2/ SOPIX® sensor holder

size 1 or Size 2

32,90 € 926039



Sheaths for SOPIX®2/ SOPIX®

(500 pieces in a single pasteboard)
for size 1 SOPIX®2 series sensors
for size 2 SOPIX®2 series sensors

276,60 € 403026

276,60 € 403027



USB2.0 active repeater cable (Booster)

length: 5m

96.60 € 700381



ACTEON® Imaging Suite⁽¹⁾ (AIS)

USB stick

720,00 € 990317

(1) - Class IIb Medical device (IMQ) - CE0051 - Manufacturer: de Gotzen ACTEON® Group - Italy

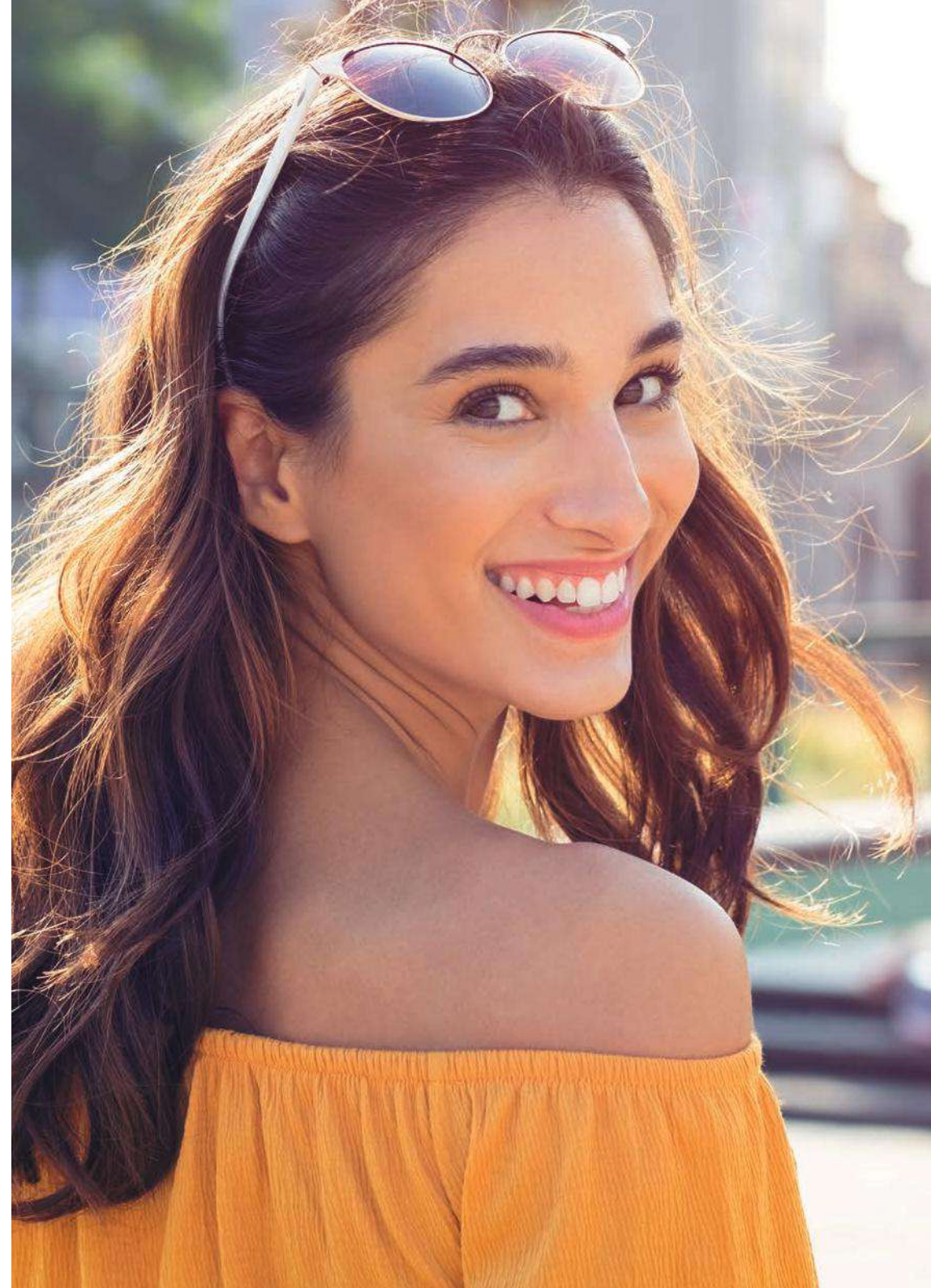

u.sense HD

u.sense



- Striking contrast for better tissue differentiations
- High resolution images 25lp/mm
- 3 seconds acquisition time
- Direct connection to the computer
- 2 sizes to meet any application needs

U-SENSE HD



U-SENSE HD Size 1*	3.375,50 €	W1300003
U-SENSE HD Size 2*	4.500,70 €	W1300004

CMOS sensor with optic fiber of 1.5 million of pixels (size 1) or 2.21 millions of pixels (size 2), theoretical resolution of 25lp/mm, actual resolution > 18lp/mm, 3.0 m USB cable.

with a sensor holder, 20 sensor sheaths, the ACTEON® Imaging Suite (AIS) software.

U-SENSE



U-SENSE Size 1*	2.700,40 €	W1300001
U-SENSE Size 2*	3.825,60 €	W1300002

CMOS sensor with optic fiber of 1.5 million of pixels (size 1) or 2.21 millions of pixels (size 2), theoretical resolution of 25lp/mm, actual resolution > 14lp/mm, 3.0 m USB cable.

with a sensor holder, 20 sensor sheaths, the ACTEON® Imaging Suite (AIS) software.

*please address to your ACTEON® contact the to check the availability of this product in your country

Accessories

ACTEON® Imaging Suite (AIS) software



ACTEON® Imaging Suite (AIS)
USB stick

720,00 €

990317

Class IIb Medical device (IMQ) - CE0051 - Manufacturer: de Gotzen ACTEON® Group - Italy

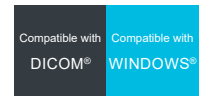

	WINDOWS® MINIMUM CONFIGURATION REQUIRED	MAC® MINIMUM CONFIGURATION REQUIRED
Processor	Intel i5 4 cores - 8 threads	Intel i5 4 cores - 8 threads
Hard disk	300 GB	300 GB
RAM	4 GB	4 GB
Graphic card	Compatible OPEN GL 2.1 (suggested an NVIDIA GT/GTX) or alternatively DriectX 9 or 11 Graphic device	Compatible OPEN GL 2.1
Screen resolution	1280 x 1024	1680 x 1050
Network card	100 Mb	100 Mb
Operation system	Windows 10 PRO 64 bits	macOS Catalina (10.15)

COLOR IMAGERY

.....



YOUR VIEW. WHERE OTHERS CAN ONLY IMAGINE

C50

- Full HD
- Vision mode
- Auto focus
- Macro vision
- 5 cameras shots* available in ONE camera



Improved patient follow-up

- More information about your patients: age, illnesses, diet, oral hygiene, etc.
- Lasting trust between you and your patients.

C50 with diag aid	4.463,00 €	S_C50_0001
C50 without diag aid	3.090,00 €	S_C50_0002

with ACTEON® Imaging Suite (AIS) software and its licence.

Class I medical device - CE - Manufacturer: Sopro ACTEON® Group - France

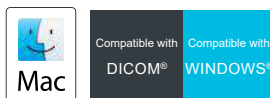

ALL YOU NEED TO SEE AT YOUR FINGERTIPS

Unprecedented vision with Daylight mode

- Improved interpretation of tooth shades with rendering of natural colors.
- A powerful support for controlling pathologies, post-treatment and facilitate the follow up process.

Exclusive macrovision performance

- Extreme visibility for ultra-precise diagnosis.

But also...

- Crystal clear vision with greater depth of field.
- A single camera for all shots: macro, intraoral, tooth, smile and portrait.



	WINDOWS® MINIMUM CONFIGURATION REQUIRED	MAC® MINIMUM CONFIGURATION REQUIRED
Processor	Intel i5 4 cores - 8 threads	Intel i5 4 cores - 8 threads
Hard disk	300 GB	300 GB
RAM	4 GB	4 GB
Graphic card	Compatible OPEN GL 2.1 (suggested an NVIDIA GT/GTX) or alternatively DriectX 9 or 11 Graphic device	Compatible OPEN GL 2.1
Screen resolution	1280 x 1024	1680 x 1050
Network card	100 Mb	100 Mb
Operation system	Windows 10 PRO 64 bits	macOS Catalina (10.15)

soprocure

With the push of a button, SOPROCARE® instantly and easily highlights

- Caries
- Plaque
- Calculus
- Gingival inflammation



PERIO Mode

SELECTIVE CHROMATIC AMPLIFICATION
3 needs, 3 modes

- PERIO mode: highlight plaque, calculus, and gingival inflammation.
- CARIO mode: caries are detected as red, surrounding tissue is displayed in black and white.
- DAYLIGHT mode: communicate more effectively with your patient and see details that are not visible with the naked eye.



CARIO Mode



DAYLIGHT Mode

SOPROCARE® is an unparalleled communication tool in the dental practice!

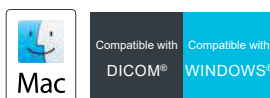

SOPROCARE® handpiece SOPRO Imaging software and its licence. 2.700,40 € S_950_0001

 **SOPROCARE®**
+ Mini Dock USB2 3.038,50 € S_950_0001 + S_717_1600

 **SOPROCARE®**
+ Mini Dock U USB2⁽¹⁾ S_950_0001 + MINI DOCK U_USB2

SOPROCARE® handpiece ACTEON® Imaging Suite (AIS) software and its licence. 2.700,40 € S_950_0008

 **SOPROCARE®**
+ Mini Dock USB2 3.038,50 € S_950_0008 + S_717_1602

 **SOPROCARE®**
+ Mini Dock U USB2⁽¹⁾ S_950_0008 + MINI DOCK U_USB2

(1) Mini Dock U USB2 : Built-in docking station with USB2 output.

Class I medical devices - CE - Manufacturer: Sopro ACTEON® Group - France

	WINDOWS® MINIMUM CONFIGURATION REQUIRED	MAC® MINIMUM CONFIGURATION REQUIRED
Processor	Intel i5 4 cores - 8 threads	Intel i5 4 cores - 8 threads
Hard disk	300 GB	300 GB
RAM	4 GB	4 GB
Graphic card	Compatible OPEN GL 2.1 (suggested an NVIDIA GT/GTX) or alternatively DirectX 9 or 11 Graphic device	Compatible OPEN GL 2.1
Screen resolution	1280 x 1024	1680 x 1050
Network card	100 Mb	100 Mb
Operation system	Windows 10 PRO 64 bits	macOS Catalina (10.15)

sopro617

- Easy to use
- Patient communication
- Great asset for case acceptance



INTRAORAL





USE AN IMAGE, THE KEY TO EDUCATION AND CASE ACCEPTANCE

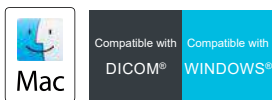

- Rounded shape and thin distal part for maximum accessibility and unrivalled patient comfort
- 105° angle of view for better exploration of distal areas
- Fixed focus with large depth of field, providing high-quality images
- Ease of use: point and shoot
- Freeze the image with a simple slide over the SOPRO® Touch 

ONE TOOTH







SOPRO® 617 handpiece SOPRO Imaging software and its licence. 1.069,20 € S_617_0001

 **SOPRO® 617**
+  **Mini Dock USB2** 1.350,20 € S_617_0001 + S_717_1600

 **SOPRO® 617**
+  **Mini Dock U USB2⁽¹⁾** S_617_0001 + MINI DOCK U_USB2

SOPRO® 617 handpiece ACTEON® Imaging Suite (AIS) software and its licence. 1.069,20 € S_617_0031

 **SOPRO® 617**
+  **Mini Dock USB2** 1.350,20 € S_617_0031 + S_717_1602

 **SOPRO® 617**
+  **Mini Dock U USB2⁽¹⁾** S_617_0031 + MINI DOCK U_USB2

(1) Mini Dock U USB2 : Built-in docking station with USB2 output.
Class I medical devices - CE - Manufacturer: Sopro ACTEON® Group - France

	WINDOWS® MINIMUM CONFIGURATION REQUIRED	MAC® MINIMUM CONFIGURATION REQUIRED
Processor	Intel i5 4 cores - 8 threads	Intel i5 4 cores - 8 threads
Hard disk	300 GB	300 GB
RAM	4 GB	4 GB
Graphic card	Compatible OPEN GL 2.1 (suggested an NVIDIA GT/GTX) or alternatively DriectX 9 or 11 Graphic device	Compatible OPEN GL 2.1
Screen resolution	1280 x 1024	1680 x 1050
Network card	100 Mb	100 Mb
Operation system	Windows 10 PRO 64 bits	macOS Catalina (10.15)

Docking stations



Mini Dock USB2

docking station USB2.0 Including one 2.5 meters linking cable and one 0.8 meter repeater cable - the **ACTEON® Imaging Suite (AIS) software**.

408,40 € S_717_1602



Mini Dock USB2

docking station USB2.0 Including one 2.5 meters linking cable and one 0.8 meter repeater cable - **SOPRO Imaging software and its licence**.

408,40 € S_717_1600



Mini Dock U USB2

built-in docking station with USB2 output
Please select the accessories for this module on next page

MINI DOCK U_USB2

Class I medical devices - CE - Manufacturer: Sopro ACTEON® Group - France

ACTEON® Imaging Suite (AIS) software



ACTEON® Imaging Suite⁽²⁾ (AIS)
USB stick

720,00 € 990317

Class IIb Medical device (IMQ) - CE0051 - Manufacturer: de Gotzen ACTEON® Group - Italy

SOPRO Imaging Suite software

SOPRO Imaging software Windows



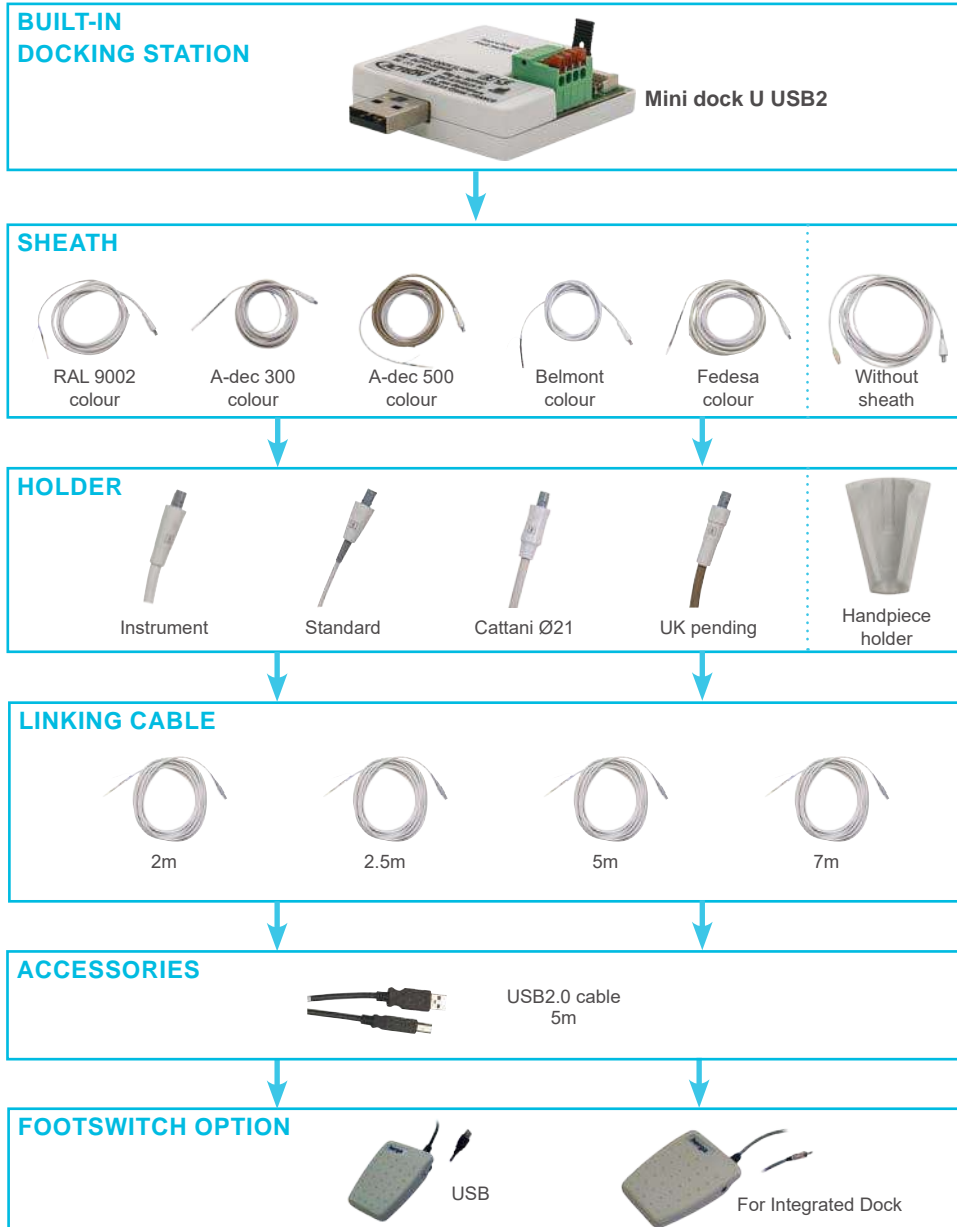
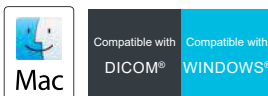

123,60 € 505036

SOPRO Imaging software MAC

123,60 € 505022



Accessories

	USB2 footswitch for image memory	230,50 €	009009
	Sheaths for SOPROLIFE®, SOPROCARE® or SOPRO® 717 First 500 pieces in a single pasteboard	255,80 €	403017
	Sheaths for SOPRO® 617 500 pieces in a single pasteboard	255,80 €	403023
	Sheaths for SOPRO® 595 500 pieces in a single pasteboard	255,80 €	403001
	Sheaths for C50® 500 pieces in a single pasteboard	309,10 €	403050
	Handpiece holder for SOPROLIFE®, SOPROCARE®, Sopro® 717 First, SOPRO® 617 and SOPRO® 595 only for unsheathed linking cables	38,40 €	926063
	SOPROTIPS for SOPROLIFE® and SOPROCARE® protection tip against light sterilization by autoclave (set of 4 pieces)	73,50 €	990135
	C50® tips protection tip against light sterilization by autoclave (set of 4 pieces)	73,50 €	990314

Cables

	USB2.0 active repeater cable (Booster) length: 5m	96,60 €	700381
--	---	----------------	---------------

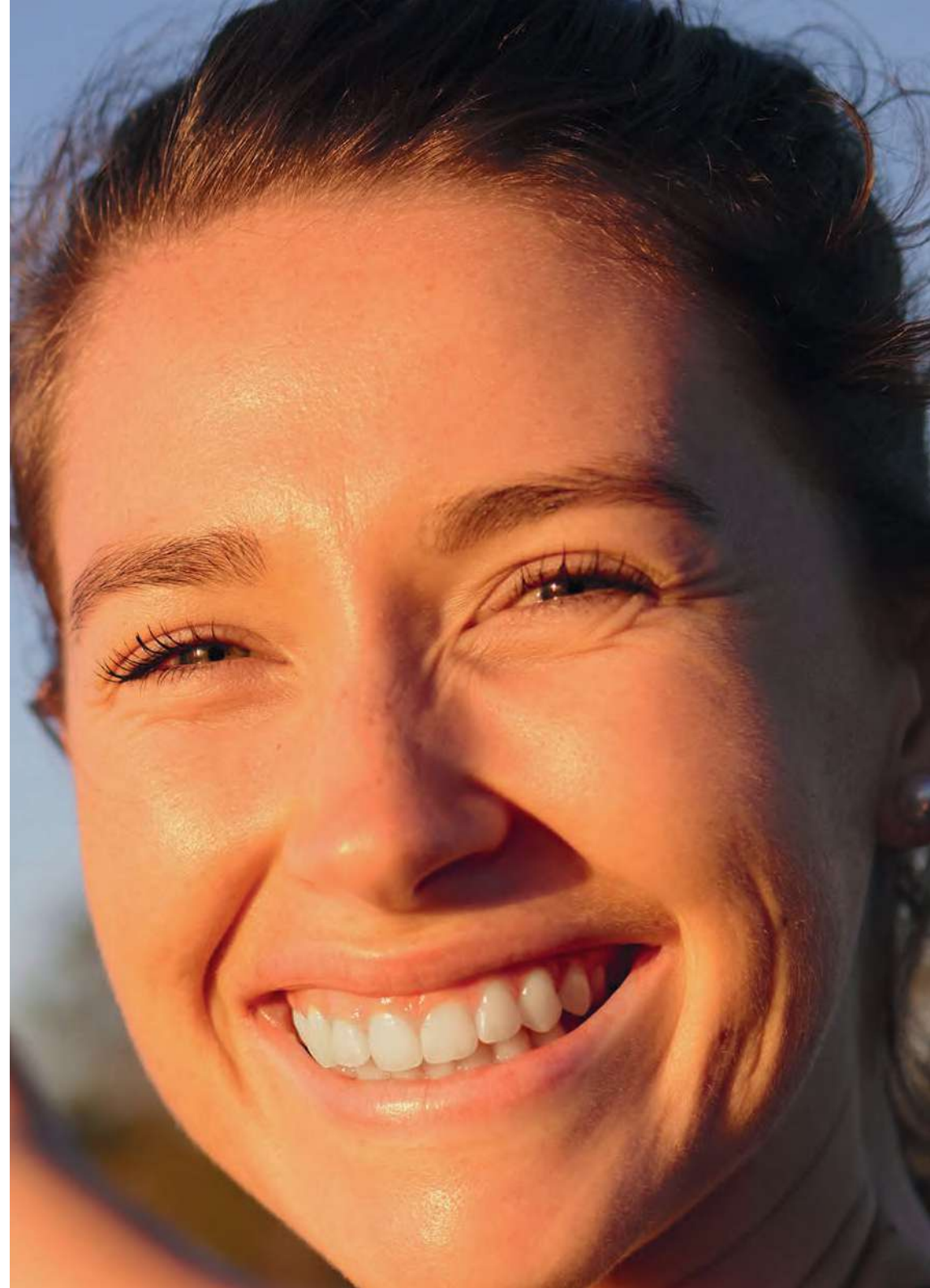

Windows connection

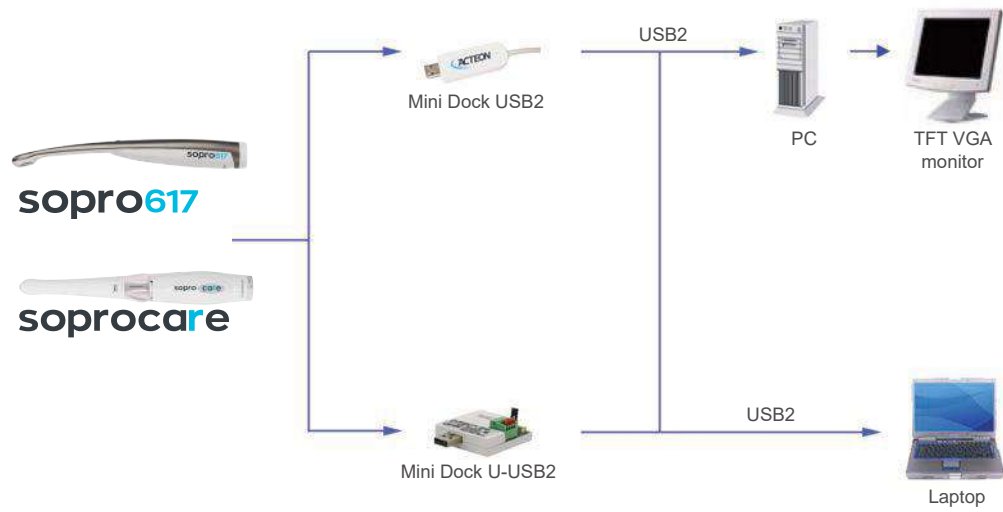
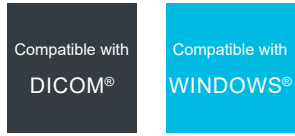

Mac connection

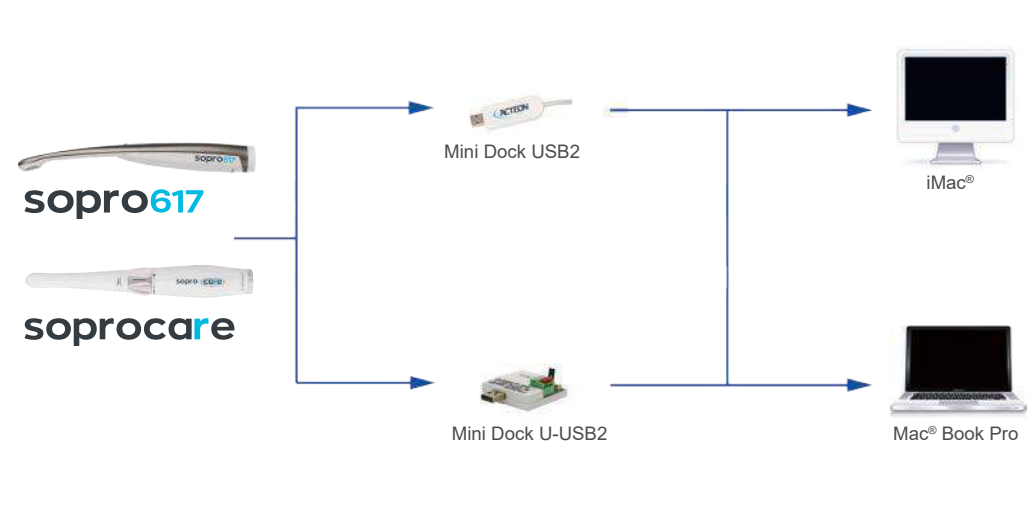
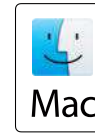

ACTEON®
EQUIPMENT

SURGERY

.....



Warning

Some accessories adapted to **PIEZOTOME® 2**, **PIEZOTOME® Solo**, **PIEZOTOME® Cube** and **IMPLANTCENTER™ 2** are not compatible with the first generation **PIEZOTOME®** and **IMPLANTCENTER™**, and vice-versa

- References compatible with 1st generation devices are indicated by a blue square : ■
- References compatible with 2nd and 3rd generation devices are indicated by a grey square : ■

3RD GENERATION

piezotome
cube



2ND GENERATION



piezotome 2

PIEZOTOME
SOLO

implant center 2

1ST GENERATION



PIEZOTOME
Piezo • Ultrasonic • Surgery • Unit

IMPLANTCENTER
Piezo • Ultrasonic • Surgery & Implantology Unit



POWERFULLY RESPONSIVE, MINIMALLY INVASIVE

piezotome cube



- Socket preservation⁽¹⁾
- Safe for soft tissues
- Recommended for immediate implant placement
- No force needed
- 50% less pain & swelling⁽²⁾
- 98% less analgesics intake⁽³⁾

Piezotome® Cube⁽¹⁾ with Essential II kit

6.790,50 € F50100

with a multifunction footswitch, a CUBE LED handpiece, 1 handpiece holder, an Essential II kit (BS1S II, BS4 II, SL1 II, SL2 II, SL3 II and LC2 II), a Piezotome® autoclave dynamometric wrench, 1 bracket, 2 sterilizable irrigation lines⁽²⁾, 5 clips and 15 perforators.

(1) Kleiber J. Immediate extraction placement and loading in the aesthetic zone. Implant Dentistry Today. 2013 Jan;7:13

(2) Shanghai Kou Qiang Yi Xue. Comparative study of complications among routine method, high speed turbine handpiece and piezosurgery device after extraction of impacted wisdom teeth. Shanghai Journal of Stomatology. 2012 Apr;21(2):208-10.

(3) Troedhan A, Kurrek A, Wainwright M. Ultrasonic Piezotome surgery: it is a benefit for our patients and does it extend surgery time? A retrospective comparative study on the removal of 100 impacted mandibular 3rd molars. Open Journal of Stomatology. 2011;1:179-184

Accessories



CUBE LED handpiece
Compatible with 2nd generation piezo tips **1.114,20 € F12816**



Multifunction footswitch **732,20 € F50109**



Handpiece holder **46,10 € F50133**



Piezotome® autoclavable dynamometric wrench **144,90 € F50150**



Irrigation line clips x10 **29,60 € F50116**



Bracket for Piezotome® Cube **53,80 € F50129**



Light ring
CUBE LED handpiece **70,30 € F12828**



Piezotome® Cube
& Tips catalog



Around Piezotome® Cube video

(1) Intraoral surgery ultrasonic control console

Class IIa medical devices (GMED) - CE 0459 - Manufacturer: SATELEC® ACTEON® Group - France

(2) Irrigation set - Class Is medical device (GMED) - CE 0459 - Manufacturer: SATELEC® ACTEON® Group - France

implant center 2



Functions

- I-Surge™: Rotative Surgery Motor
- Piezotome®: Piezo electric surgery
- Newtron®: Conventional ultrasound treatment (Scaling, perio, endo, apical surgery,...)

ImplantCenter™ 2⁽¹⁾

12.714,90 € F27200 ■

with a LED motor, a LED motor cord, a progressive footswitch, 2 brackets, 2 handpiece holders, 2 autoclavable irrigation lines⁽²⁾ and 30 perforators.

This reference does not include the Piezotome® 2 handpiece and tips.

(1) Ultrasonic control console for conventional dentistry and intraoral dentistry and motor control console for dental implantology
Class IIa medical devices (GMED) - CE 0459 - Manufacturer: SATELEC® ACTEON® Group - France

(2) Irrigation set - Class Is medical device (GMED) - CE 0459 - Manufacturer: SATELEC® ACTEON® Group - France

This system is designed exclusively for dental surgery and implant procedures performed at a dental practice. The use of the device in a hospital or clinic operating theatre constitutes a use that is excluded from the device's regulatory framework. ACTEON® offers a medical range suitable for use in the operating room. Do not hesitate to consult us for more information.

Accessories

	ImplantCenter™ progressive footswitch	1.098,80 € F27120 ■
	ImplantCenter™ 2 progressive footswitch	966,00 € F27170 ■
	Support for motor or handpiece	39,50 € F02463 ■
	Bracket	43,90 € E27113 ■
	I-Surge™ LED light micro-motor ⁽¹⁾	1.519,20 € F27210 ■
	Disconnectable I-Surge™ LED micro-motor cord	782,70 € F27211 ■
	20:1 Bien-Air* LED contra-angle ⁽²⁾ green ring	1.792,60 € F36132 ■
	I-Surge™ micro-motor ⁽¹⁾	1.260,20 € F27123 ■
	Disconnectable I-Surge™ micro-motor cord	696,00 € F27124 ■
	Disconnectable I-Surge™ micro-motor cord + micro-motor	1.969,30 € F34450 ■
	Mont Blanc 20:1 Anthogyr* contra-angle ⁽³⁾ green ring (non LED)	1.332,60 € F36140 ■
	Atomizer dropper for Mont Blanc 20:1 Anthogyr* contra-angle	53,90 € F36141 ■

* Bien-Air and Anthogyr are registered trademarks

(1) Class IIa medical devices (GMED) - CE 0459 - Manufacturer: SATELEC® ACTEON® Group - France

(2) Class IIa medical device - CE 0120 - Manufacturer: Bien Air - Distributor: SATELEC® ACTEON® Group - France

(3) Class IIa medical device (GMED) - CE 0459 - Manufacturer: Anthogyr - Distributor: SATELEC® ACTEON® Group - France

Accessories

The handpieces are equipped with keyway systems to prevent a Piezotome® tip (Bone Surgery, Sinus Lift, Extraction, etc.) from being screwed onto a Newtron® handpiece or a classic tip (scaling, periodontics, endodontics, etc.) from being screwed onto a Piezotome® handpiece.

	Piezotome® handpiece⁽¹⁾ + cord	1.164,70 €	F57321
	Piezotome® LED handpiece⁽¹⁾ + cord	1.142,20 €	F12815
	Piezotome® Solo handpiece⁽¹⁾ + cord	1.071,40 €	F57509
	Newtron® handpiece⁽²⁾	478,60 €	F12281
	Newtron® LED handpiece⁽²⁾	669,60 €	F12609
	Newtron® cord	844,10 €	F57305
	Newtron® cord	844,10 €	F12850
	Newtron® LED cord	844,10 €	F12830
	Light ring	61,50 €	F12821
	Piezotome® autoclavable dynamometric wrench	144,90 €	F50150
	Bracket	43,90 €	E27113

(1) Intraoral surgery ultrasonic handpieces - Class IIa medical device (GMED) - CE 0459 - Manufacturer: SATELEC® ACTEON® Group - France
 (2) Dental ultrasonic handpieces - Class IIa medical device (GMED) - CE 0459 - Manufacturer: SATELEC® ACTEON® Group - France



ImplantCenter™ cart

dimensions (DxWxH) : 66 x 54 x 79cm
 3 glass trays: 60 x 50cm
 connections for water and electricity

1.292,40 € F27125



Piezotome® 2 pack⁽¹⁾ (without tip)
 with an autoclavable Piezotome® 2
 handpiece with cord and a Piezotome®
 wrench

1.857,30 € F87523



Sterilization box

444,60 € F27156



Universal irrigation lines⁽²⁾ Sterile x10
 single-use with integrated cassette and
 flow control system

130,60 € F59905



Autoclavable irrigation line⁽²⁾ x1
 + 10 sterile perforators⁽³⁾

109,80 € F57374



Autoclavable irrigation line⁽²⁾ x1

84,50 € E59920



Disposable sterile perforators⁽³⁾ x10

35,10 € F57372



Irrigation line clip

220,00 € E57353



Piezotome® 2 progressive footswitch

957,20 € F57404



**Piezotome® Solo and
 Piezotome® Solo LED footswitch**

923,20 € F57404

(1) Class IIa medical device (GMED) - CE 0459 - Manufacturer: SATELEC® ACTEON® Group - France

(2) Irrigation set - Class Is medical device (GMED) - CE 0459 - Manufacturer: SATELEC® ACTEON® Group - France

(3) Class Is medical devices (GMED) - CE 0459 - Manufacturer: SATELEC® ACTEON® Group - France

Bone surgery



Bone Surgery pack

with an autoclavable Piezotome® handpiece with cord, a Bone Surgery II kit and a Piezotome® autoclave dynamometric wrench

2.475,40 € F87500 ■



Bone Surgery II kit

with BS1S II, BS2L II, BS2R II, BS4 II, BS5 II, BS6 II tips, an autoclavable metal support, an autoclavable universal wrench

1.350,20 € F87509 ■

Bone Surgery II kit support

76,80 € X88456 ■

Saws



BS2L II - Left-angled

197,60 € F87502 ■

BS2R II - Right-angled

197,60 € F87503 ■



BS1S II "Slim" - Depth of cut 9mm

197,60 € F87525 ■

BS1L II "Long" - Depth of cut 15mm with universal wrench

218,40 € F87527 ■

BS1RD II - Rounded saw, 280° of active surface

197,60 € F87557 ■

Scrapers



BS4 II

197,60 € F87504 ■

BS5 II

197,60 € F87505 ■

BS6 II

197,60 € F87506 ■



Sinus lift



Sinus Lift pack

with a sterilization box, an autoclavable Piezotome® handpiece with cord, a Sinus Lift II kit and a Piezotome® autoclave dynamometric wrench

2.475,40 € F87510 ■



Sinus Lift II kit

with SL1 II, SL2 II, SL3 II, SL4 II, SL5 II tips, an autoclavable metal support, an autoclavable universal wrench

777,20 € F87519 ■

Sinus Lift II kit support

76,80 € X88457 ■



SL1 II

141,60 € F87511 ■

SL2 II

141,60 € F87512 ■



SL3 II

141,60 € F87513 ■

SL4 II

141,60 € F87514 ■

SL5 II

141,60 € F87515 ■



Intralift



Intralift™ pack

with a sterilization box, an autoclavable Piezotome® handpiece with cord, an Intralift II kit, an autoclavable universal wrench

2.397,40 € **F87530**



Intralift™ II kit

with TKW1 II, TKW2 II, TKW3 II, TKW4 II, TKW5 II tips, an autoclavable metal support, an autoclavable universal wrench

1.350,20 € **F87536**

Intralift™ II kit support

76,80 € **X88458**

TKW1 II - Conical tip Ø1.35mm (pilot drilling)

208,60 € **F87531**

TKW2 II - Cylindrical tip Ø2.1mm (preliminary drilling)

208,60 € **F87532**

TKW3 II - Cylindrical tip Ø2.35mm (preliminary drilling)

208,60 € **F87533**

TKW4 II - Cylindrical tip Ø2.8mm (secondary drilling)

208,60 € **F87534**

TKW5 II - Non cutting "trumpet" tip (sinus membrane elevation)

208,60 € **F87535**



Extraction



Extraction pack

with a sterilization box, an autoclavable Piezotome® handpiece with cord, an Extraction II kit and a Piezotome® autoclavable dynamometric wrench

2.082,40 € **F87540**



Extraction II kit

with LC1 II, LC2 II (x2), LC2L II, LC2R II, Ninja® II tips, an autoclavable metal support, an autoclavable universal wrench

1.002,20 € **F87546**

Extraction II kit support

76,80 € **X88459**

LC1 II

143,80 € **F87507**

LC2 II

143,80 € **F87542**

LC2L II

143,80 € **F87543**

LC2R II

143,80 € **F87544**

Ninja® II

196,50 € **F87545**

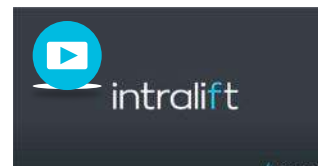
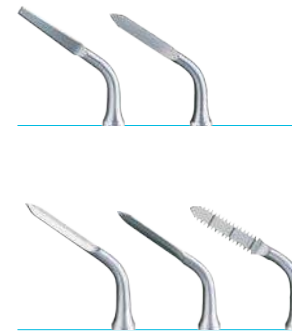

Crown extension

**Crown Extension pack**

with a sterilization box, an autoclavable Piezotome® handpiece with cord, a Crown Extension II kit and a Piezotome® autoclavable dynamometric wrench

1.598,30 € **F87550** ■

**Crown Extension II kit**

with BS6 II, CE1 II, CE2 II, CE3 II tips, an autoclavable metal support, an autoclavable universal wrench

653,10 € **F87554** ■



CE1 - Diamond-coated spherical tip
Ø1.75mm

141,60 € **F87551** ■



CE2 - Diamond-coated spherical tip
Ø1.20mm

141,60 € **F87552** ■



CE3 - Diamond-coated straight tip on
5mm (laser mark placed at 3mm:
biologic width)

141,60 € **F87553** ■



BS6 II

197,60 € **F87506** ■



Crest splitting

**Crest Splitting pack**

with a sterilization box, an autoclavable Piezotome® LED handpiece with cord, a Crest Splitting II kit and a Piezotome® autoclavable dynamometric wrench

2.014,30 € **F87560** ■

**Crest Splitting II kit**

with CS1 II, CS2 II, CS3 II, CS4 II, CS5 II, CS6 II tips, an autoclavable metal support, an autoclavable universal wrench

889,20 € **F87567** ■

Crest Splitting II kit support

76,80 € **X88464** ■

CS1 II

141,60 € **F87561** ■

**CS2 II**

141,60 € **F87562** ■

CS3 II

141,60 € **F87563** ■

CS4 II

141,60 € **F87564** ■

**CS5 II**

186,60 € **F87565** ■

CS6 II

186,60 € **F87566** ■



Piezocision™

Piezocision™ pack

with a sterilization box, an autoclavable Piezotome® LED handpiece with cord,
a Piezocision™ II kit and an autoclavable universal wrench

1.733,30 € **F87570** ■

**Piezocision™ II kit**

with PZ1 II, PZ2L II, PZ3R II, PZ3 II tips,
an autoclavable metal support and an
autoclavable universal wrench

777,20 € **F87576** ■

Piezocision™ II kit support

76,80 € **X88472** ■

**PZ1 II - Anterior corticotomies**

196,50 € **F87571** ■

PZ2L II - (left oriented)

Lateral corticotomies on
patient's right vestibular arch
To be used with pendulum
motion

196,50 € **F87572** ■

**PZ2R II - (right oriented)**

Lateral corticotomies on
patient's left vestibular arch
To be used with pendulum
motion

196,50 € **F87573** ■

**PZ3 II - Anterior corticotomies
for root proximity concerns**

196,50 € **F87574** ■



Other packs & kits

**Essential pack**

with a sterilization box, an autoclavable
Piezotome® 2 handpiece with cord and
an Essential II Kit and a Piezotome®
autoclavable dynamometric wrench

2.194,30 € **F87529** ■

**Essential II kit**

with BS1S II, BS4 II, SL1 II, SL2 II, SL3
II, LC2 II tips, an autoclavable metal
support, an autoclavable universal
wrench

1.350,20 € **F87528** ■

**Newtron® perio pack**

with a sterilization box, an autoclavable
Newtron® handpiece, an autoclavable
Newtron® cord, a Newtron® Perio
kit and a Piezotome® autoclavable
dynamometric wrench

2.082,40 € **F87520** ■

Newtron® pack (without tip)

with a sterilization box, an autoclavable Newtron® LED handpiece, an
autoclavable LED cord and a Piezotome® autoclavable dynamometric
wrench

1.744,30 € **F87524** ■

**Newtron® Implant Protect Kit**

with IP1, IP2L, IP2R, IP3L and IP3R
tips,
an autoclavable metal support,
an autoclavable universal wrench

574,10 € **F02120** ■

**Newtron® kit support**

76,80 € **X88451** ■

Important

Newtron® kits are compatible with the Newtron® and Newtron® LED handpieces

servotome







High frequency electrosurge or orthodontics, periodontics and other oral surgery

Servotome® II 1.485,20 € **F57210**

with a single footswitch, a box with 10 electrodes, a conductive bracelet.

Intraoral electrosurgery control console - Class IIb medical device (GMED) - CE 0459 - Manufacturer: SATELEC® ACTEON® Group - France

Accessories

	Conductive bracelet	211,90 €	F57226
	Electrode holder⁽¹⁾	253,60 €	F00476
	Electrode holder cord (2m)	51,60 €	F00475
	Servotome® II footswitch	130,60 €	F00059

(1) Class IIb medical device (GMED) - CE 0459 - Manufacturer: SATELEC® ACTEON® Group - France

Electrodes

	10 electrodes kit	462,10 €	F10440
	10 electrodes + 1 electrode holder kit	518,10 €	F10472
	I 22 S	56,00 €	F10421
	I 22 CA	56,00 €	F10422
	TR 22L	56,00 €	F10424
	TR 22 R	56,00 €	F10425
	TR 22 T	56,00 €	F10427
	FC 25 B	56,00 €	F10428
	FC 32 B	56,00 €	F10429
	FC 10 N	56,00 €	F10430
	I 40 S	56,00 €	F10431
	I 40 CA	56,00 €	F10432

Class IIb medical device (GMED) - CE 0459 - Manufacturer: SATELEC® ACTEON® Group - France

ULTRASONICS

.....



EVERYDAY, FOR EVERY CLINICAL SITUATION

PRECISION

Precise treatments thanks to the controlled linear vibrations

PRESERVATION

Tissue preservation with the automatic and continuous frequency adjustment



COMFORT

Comfort for the patient and practitioner thanks to the real time power adjustment



A large range of tips meeting all the clinical needs

The widest range on the market with **80 different tips**; with exclusive designs, alloys and coatings for clinical versatility.
Exclusive tips in Pure Titanium for implant cleaning.

PERIODONTICS



IMPLANT CARE



ENDODONTICS



SURGICAL ENDODONTICS



PROPHYLAXIS



CONSERVATIVE AND RESTORATIVE DENTISTRY

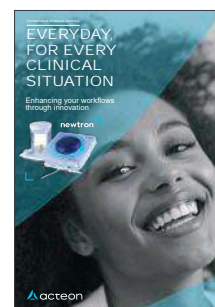

Newtron® range & Tips catalog



Scaling TipCard
Tip wear guide for scaling tips



Perio TipCard
Tip wear guide for periodontal tips

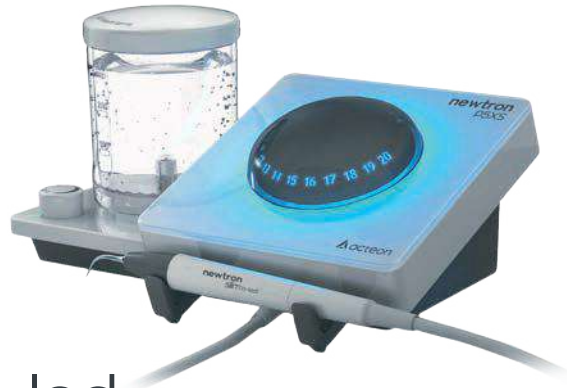

newtron

p5XS b-led



Newtron® P5XS B.LED

1.890,30 €

F62100

with a non-disconnectable footswitch, a power supply, a Newtron® SLIM B.LED handpiece cord, a Newtron® SLIM B.LED handpiece with a blue ring, a Newtron® SLIM B.LED white LED ring, a F.L.A.G™ for B.LED (5x 1.5ml) dental plaque discloser, an autoclavable universal wrench, 3 tips (N°1, N°1S, N°H3) and a 300ml tank

Dental ultrasonic control console - Class IIa medical device (GMED) - CE 0459 - Manufacturer: SATELEC® ACTEON® Group - France



Important

Handpieces compatible with all ACTEON® Equipment Dental Tips (with color coded ring: Color Coding System™)



newtron

p5 b-led



Newtron® P5 B.LED

1.553,30 €

F61101

with a non-disconnectable footswitch, a power supply, a Newtron® SLIM B.LED handpiece cord, a Newtron® SLIM B.LED handpiece with a blue ring, a Newtron® SLIM B.LED white LED ring, a F.L.A.G™ for B.LED (5x 1.5ml) dental plaque discloser, a N°1 tip and an autoclavable universal wrench

Dental ultrasonic control console - Class IIa medical device (GMED) - CE 0459 - Manufacturer: SATELEC® ACTEON® Group - France



Important

Handpieces compatible with all ACTEON® Equipment Dental Tips (with color coded ring: Color Coding System™)

newtron booster



Newtron® Booster

1.238,20 €

F60203

with a Newtron® non-disconnectable footswitch, a power supply, a Newtron® handpiece cord, a Newtron® handpiece, a N°1 tip and an autoclavable universal wrench

Dental ultrasonic control console - Class IIa medical device (GMED) - CE 0459 - Manufacturer: SATELEC® ACTEON® Group - France



Important

Handpieces compatible with all ACTEON® Equipment Dental Tips
(with color coded ring: Color Coding System™)

newtron p5XS

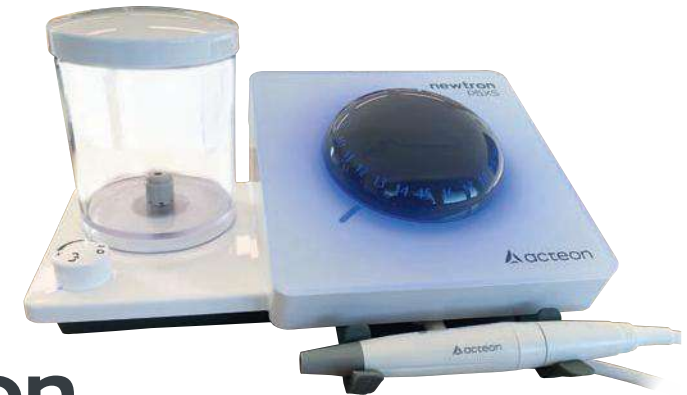

Newtron® P5 XS

1.665,20 €

F62111

with a Newtron® non-disconnectable footswitch, a power supply, a Newtron® handpiece cord, a Newtron® handpiece, a N°3 tip (N.1-1S-10Z) and an autoclavable universal wrench

Dental ultrasonic control console - Class IIa medical device (GMED) - CE 0459 - Manufacturer: SATELEC® ACTEON® Group - France



Important

Handpieces compatible with all ACTEON® Equipment Dental Tips
(with color coded ring: Color Coding System™)

Tips

scaling



N°1 - Universal 86,70 € *F00246*

N°2 - High power 86,70 € *F00247*

N°3 - Removing stains 86,70 € *F00248*

10P - Supra and sub-gingival < 3mm 86,70 € *F00253*



10X - Interproximal 99,90 € *F00359*

10Z - Subgingival 99,90 € *F00254*

N°1S - Supra and sub-gingival 86,70 € *F00245*

periofine



PFU - Universal 133,90 € *F02170*

PFL - Left-angled 133,90 € *F02171*

PFR - Right-angled 133,90 € *F02172*

Tips

periodontics

Curettes & debridement



H1 - Anterior teeth, diamond-coated 99,90 € *F00366*

H2L - Premolars & molars, left-angled 99,90 € *F00367*

H2R - Premolars & molars, right-angled 99,90 € *F00368*

H3 - Anterior teeth, curette 99,90 € *F00369*



H4L - Premolars & molars, left-angled 99,90 € *F00114*

H4R - Premolars & molars, right-angled 99,90 € *F00115*

implantprotect pure titanium

Peri-implantitis treatment



IP1 - Implant abutments and wide threads 99,90 € *F02121*

IP2L - Medium implant threads, left-angled 157,00 € *F02122*

IP2R - Medium implant threads, right-angled 157,00 € *F02123*



IP3L - Narrow implant threads, left-angled 157,00 € *F02124*



IP3R - Narrow implant threads, right-angled 157,00 € *F02125*

Tips

perio maintenance

Periodontal maintenance

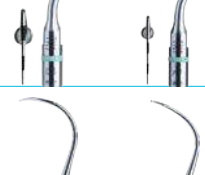



	TK1-1S - Short probe	133,90 €	F01001
	TK1-1L - Long probe	133,90 €	F01004
	TK2-1L - Premolars & molars, left-angled	133,90 €	F02162
	TK2-1R - Premolars & molars, right-angled	133,90 €	F02161



periosoft

implant maintenance



	PH1 - Anterior teeth (x4)	133,90 €	F00702
	PH2L - Premolars & molars, left-angled (x4)	133,90 €	F00705
	PH2L - Premolars & molars, right-angled (x4)	133,90 €	F00706

perio precision

	P2L - Narrow pockets debridement, left-angled	133,90 €	F00090
	P2R - Narrow pockets debridement, right-angled	133,90 €	F00091

Tips

endodontics

Endodontics - Irrigation



	K10-21 - Ø 0.1/length 21mm (x4)	56,00 €	F43710
	K10-25 - Ø 0.1/length 25mm (x4)	56,00 €	F43712
	K15-21 - Ø 0.15/length 21mm (x4)	56,00 €	F43715
	K15-25 - Ø 0.15/length 25mm (x4)	56,00 €	F43717
	K25-21 - Ø 0.25/length 21mm (x4)	56,00 €	F43725
	K25-25 - Ø 0.25/length 25mm (x4)	56,00 €	F43727
	K30-21 - Ø 0.30/length 21mm (x4)	56,00 €	F43730
	K30-25 - Ø 0.30/length 25mm (x4)	56,00 €	F43732

irrisafe

Passive Ultrasonic Irrigation



	IRR 20-21 - Ø 0.2/length 21mm (x4)	112,00 €	F43807
	IRR 20-25 - Ø 0.2/length 25mm (x4)	112,00 €	F43808
	IRR 25-21 - Ø 0.25/length 21mm (x4)	112,00 €	F43805
	IRR 25-25 - Ø 0.25/length 25mm (x4)	112,00 €	F43806

Tips

endosurgery

Apical surgery



P14D - Universal 133,90 € *F00106*

S12-70D - 70° Universal 133,90 € *F00118*



P15LD - Left-angled 133,90 € *F00107*

P15RD - Right-angled 133,90 € *F00108*

endodontics

Retreatment



ET40 - Length 40mm 108,70 € *F88012*

ET40D - Length 40mm, diamond-coated 108,70 € *F88014*



ET20D - Length 20mm, diamond-coated 108,70 € *F88013*

SO4 - Gutta Percha condenser 133,90 € *F88009*

Tips

endosuccess
apical surgery

AS3D - Universal, Length 3mm 133,90 € *F00065*

AS6D - Length 6mm 133,90 € *F00079*

AS9D - Length 9mm 133,90 € *F00067*

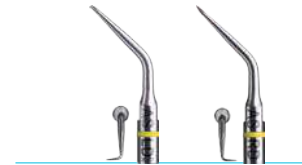

ASLD - Length 3mm, left-angled (premolars) 133,90 € *F00080*

ASRD - Length 3mm, right-angled (premolars) 133,90 € *F00081*

endosuccess
retreatment

Retreatment



ET18D - Cavity access finishing 108,70 € *F88017*

ETBD - Exploration 108,70 € *F88020*



ET25S - Short Ti-Nb tip 108,70 € *F88021*

ET25 - Ti-Nb tip 108,70 € *F88018*

ET25L - Long Ti-Nb tip 108,70 € *F88022*



ET20 - Universal 108,70 € *F88011*

ET20R - Loosening 133,90 € *F88019*

Tips

endosuccess canal access prep



CAP1 - Cavity preparation	133,90 €	F88181
CAP2 - Canal localization	133,90 €	F88182
CAP3 - Canal opening	133,90 €	F88183

perfect margin rounded

Prosthetic finishing (rounded)

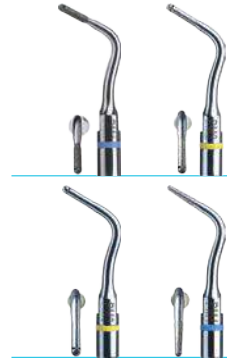

PM1 - Preparation of the dentin	99,90 €	F02250
PM2 - Preparation/finishing	99,90 €	F02251
PM3 - Finishing	99,90 €	F02252
PM4 - Corono-radicular preparation, conical, diamond-coated 46µm	99,90 €	F02253

Tips

Prosthesis



C20 - Inlay/onlay condensation	99,90 €	F00113
Piezocem caps x10	65,90 €	F00397
5AE - Loosening with spray	114,20 €	F00249

Tip kits

**Scaling kit**

with an autoclavable plastic box, N°1, N°1S, N°10X, H3 tips, four autoclavable dynamometric Newtron® wrenches

453,40 €

F00934



scaling

**Hygiene kit**

with an autoclavable plastic box, N°1, N°1S, 10Z, TK1-1S tips, four autoclavable dynamometric Newtron® wrenches

453,40 €

F00935



hygiene

**Perio kit**

with an autoclavable plastic box, N°1S, H3, H4L, H4R tips, four autoclavable dynamometric Newtron® wrenches

453,40 €

F00936



periodontics

**PerioPrecision kit**

with an autoclavable plastic box, P2L, P2R, TK1-1S tips and three autoclavable dynamometric Newtron® wrenches

453,40 €

F00939

perio
precision**Perio Maintenance kit (BDR)**

with an autoclavable plastic box, TK1-1S, TK1-1L, TK2-1L, TK2-1R tips, four autoclavable dynamometric Newtron® wrenches

453,40 €

F00937

perio
maintenance
BDR

Tip kits

**Implant Protect kit**

with IP1, IP2L, IP2R, IP3L and IP3R tips, an autoclavable metal support and an autoclavable universal wrench

574,10 €

F02120

implantprotect
pure titanium**Endo One kit**

with CAP1, CAP2, CAP3, ET25, ETPR tips, 1 blister of 4 IrriSafe™ 25-21mm tips, an autoclavable metal support and an autoclavable universal wrench

585,10 €

F00732

endo
one**Endo Success™ Retreatment kit**

with ET18D, ET20, ET25, ET25S, ETBD, ETPR tips, an autoclavable metal support and an autoclavable universal wrench

597,20 €

F00737

endosuccess
retreatment**Perfect Margin® Rounded kit**

with PM1, PM2, PM3, PM4 tips, an autoclavable metal support and an autoclavable universal wrench

328,20 €

F00738

perfect margin
rounded**Hygiene kit PLUS**

with an autoclavable plastic box, three autoclavable dynamometric Newtron® wrenches and a Newtron® handpiece

834,30 €

F00940



hygiene

Tip kits



Endo Success™ Canal Access Prep kit
with CAP1, CAP2, CAP3 tips,
an autoclavable metal support and
an autoclavable universal wrench

337,00 €

F88180

endosuccess
canal access prep



Endo Success™ Apical Surgery kit
with AS3D, AS6D, AS9D, ASLD, ASRD
tips, an autoclavable metal support and
an autoclavable universal wrench

649,90 €

F00069

endosuccess
apical surgery

Boxes & Supports



Autoclavable plastic box
with 4 autoclavable dynamometric
Newtron® wrenches

194,30 €

F12352



Autoclavable plastic box
for autoclavable dynamometric wrenches

72,40 €

F12351



Newtron® kit support

76,80 €

X88451

Endo Success™ kit support

76,80 €

X88447

Perfect Margin™ kit support

76,80 €

X88448

Wrenches



Newtron® wrench
autoclavable and dynamometric

47,20 €

F81330



Universal wrench

23,10 €

F00406



Protec-Tip

15,40 €

F81281

Important

The Newtron® wrench is used with all blue, green and orange tips and with surgical endodontics tips (yellow): AS3D, AS6D, AS9D, ASLD, ASRD, S12-70D, P14D, P15LD and P15RD. For other tips with yellow ring, the universal wrench (Ref. F00406) is recommended.

Accessories

	Newtron® handpiece⁽¹⁾ without LED, autoclavable, light grey/dark grey for Newtron® Booster	478,60 €	F12281
	Newtron® SLIM handpiece⁽¹⁾ without LED for Newtron® P5	732,20 €	F12901
	Newtron® SLIM B.LED handpiece⁽¹⁾ for Newtron® P5 B.LED and Newtron® P5 XS B.LED (Bluetooth) with blue LED ring	732,20 €	F12900
	with white LED ring	732,20 €	F12905
	Nose for Newtron® handpiece	7,70 €	F12284
	Nose for Newtron® SLIM and Newtron® SLIM B.LED handpieces	12,10 €	E12904
	Newtron® SLIM B.LED blue LED ring	56,00 €	F62201
	Newtron® SLIM B.LED white LED ring	56,00 €	F12915
	Handpiece holder silicone	8,80 €	E60108



Important

Handpieces compatible with all ACTEON® Equipment Dental Tips (with color coded ring: Color Coding System™)

(1) Dental ultrasonic handpiece - Class IIa medical devices (GMED) - CE 0459 - Manufacturer: SATELEC® ACTEON® Group - France



Newtron® Booster,
Newtron® P5,
Newtron® P5 B.LED,
Newtron® P5 XS B.LED,
Newtron® P5 XS B.LED Bluetooth

	Newtron® handpiece cord non-disconnectable for Newtron® Booster	112,00 €	X00244
	White handpiece cord for P5 Newtron® XS	81,20 €	F00222
	Newtron® SLIM B.LED handpiece cord non-disconnectable for Newtron® P5 B.LED and Newtron® P5XS B.LED (Bluetooth)	169,00 €	X00226
	Non-disconnectable footswitch for Newtron® BOOSTER, Newtron® P5, Newtron® P5 B.LED and Newtron® P5XS B.LED (Bluetooth)	64,80 €	F00061
	Dental plaque discloser F.L.A.G.™ for B.LED 5 x 1.5ml	45,00 €	F62200
	Dental plaque discloser F.L.A.G.™ for B.LED 100ml	94,40 €	F62203
	300ml tank for Newtron® P5 B.LED and Newtron® P5XS B.LED (Bluetooth)	101,00 €	F62004
	500ml tank for Newtron® P5 B.LED and Newtron® P5XS B.LED (Bluetooth)	104,30 €	F62005

Accessories



Important

Handpieces compatible with all ACTEON® Equipment Dental Tips (with color coded ring: Color Coding System™)

	Newtron® handpiece⁽¹⁾ without LED, autoclavable, light grey/dark grey for Newtron® Booster	478,60 €	F12281
	Newtron® LED handpiece⁽¹⁾ autoclavable for P-Max Newtron® XS, P5 Newtron® LED and P5 Newtron® XS LED	669,60 €	F12609
	Nose for Newtron® handpiece	7,70 €	F12284
	Nose for Newtron® LED handpiece	18,70 €	E12681
	Metal nose for Newtron® LED handpiece	262,40 €	F12675
	Light ring for Newtron® LED handpiece	61,50 €	F12605
	Non-disconnectable footswitch for P5 Newtron®, P5 Newtron® LED, P5 Newtron® XS, P5 Newtron® XS LED	64,80 €	F00061
	Universal irrigation lines⁽¹⁾ Sterile x10 single-use with integrated cassette and flow control system. For Sterikit and Sterikit LED	130,60 €	F59905
	Pump cassette	7,70 €	E58543
	O ring large for Newtron® handpiece	2,20 €	E15019
	O ring small for Newtron® handpiece	2,20 €	E15052

(1) Dental ultrasonic handpiece - Class IIa medical devices (GMED) - CE 0459 - Manufacturer: SATELEC® ACTEON® Group - France



P5 Newtron®,
P5 Newtron® LED,
P5 Newtron® XS,
P5 Newtron® XS LED,
P-MAX Newtron® XS,
Prophy Max™

	White handpiece cord for P5 Newtron®	92,20 €	F00223
	White handpiece cord for P5 Newtron® XS	81,20 €	F00222
	LED handpiece cord for P5 Newtron® LED and P5 Newtron® XS LED	149,30 €	F00637
	Disconnectable LED handpiece cord for P-Max Newtron® XS	164,70 €	F00628
	Newtron® handpiece cord white, with spray adjustment for Prophy-Max™	154,80 €	F01176
	Tank with white cover	98,80 €	F58525
	Sterikit for P5 Newtron® XS with a support, a bracket, a pump cover, 5 clips, a Sterijoint and 3 sterile universal irrigation lines ⁽¹⁾	400,70 €	F58136
	Sterikit LED for P5 Newtron® XS LED with a support, a bracket, a pump cover, 5 clips, a LED Sterijoint and 3 sterile universal irrigation lines ⁽¹⁾	472,00 €	F58225
	Sterijoint adapter for Newtron® handpiece for Sterikit	219,15 €	F58703
	Sterijoint LED adapter for Newtron® LED handpiece for Sterikit LED	219,15 €	F12640

(1) Irrigation line: irrigation set - Class Is medical device (GMED) - CE 0459 - Manufacturer: SATELEC® ACTEON® Group - France

Accessories



Newtron® handpiece⁽¹⁾
without LED, autoclavable, light grey/dark grey for Newtron® Booster **478,60 €** **F12281**



Nose for Newtron® handpiece **7,70 €** **F12284**



Newtron® Cart
Color: white
990 € **F03739**
Two connections for water and electricity.
Dimensions (DxWxH): 48 x 40 x 77cm
3 glass trays: 42 x 36cm



Important

Handpieces compatible with all ACTEON® Equipment Dental Tips (with color coded ring: Color Coding System™)

(1) Dental ultrasonic handpiece - Class IIa medical devices (GMED) - CE 0459 - Manufacturer: SATELEC® ACTEON® Group - France



P5 Newtron® blue,
P5 Newtron® XS blue,
P-Max Newtron®,
P-Max Newtron® Lux,
Prophy Max™ blue,
Prophy Max™ Lux



Newtron® double-lines⁽¹⁾ kit x10
for P-Max Newtron® (Lux) and
Prophy Max™ (Lux) **189,90 €** **F59752**



Newtron® single-lines⁽¹⁾ kit x10
For P-Max Newtron® (Lux) and
Prophy Max™ (Lux) **157,00 €** **F59756**



Kit of 3 hoops
for Newtron® cord **97,70 €** **F59761**



Newtron® single footswitch **73,50 €** **F00054**











Newtron® double footswitch **221,70 €** **F00055**

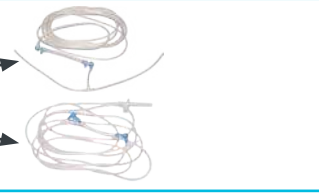

Steel water filter 60µ complete **64,10 €** **F10386**

Water filter 60µ cartridge + o'ring **15,20 €** **F10389**

(1) irrigation set - Class Is medical device (GMED) - CE 0459 - Manufacturer: SATELEC® ACTEON® Group - France

Devices		Corresponding lines	Designation	REF.
 <p>1 - Suprasson P-Max (Lux) Assortiment I 2 - Prophy Max™ (Lux) Assortiment I 3 - P5 Newtron® XS (LED) + Sterikit 4 - Suni 2nd generation 5 - Suni Max 6 - Trans'care Max</p>			<p>Universal irrigation lines⁽¹⁾ sterile x10 single-use with integrated cassette and flow control system</p>	<p>F59905</p>
 <p>7 - Piezotome® 8 - Piezotome® 2 9 - ImplantCenter™ 10 - ImplantCenter™ 2 11 - Piezotome® Solo 12 - Piezotome® Cube 13 - I-Surge™ old generation 14 - I-Surge™ 15 - EndoCenter</p>			<p>Autoclavable irrigation lines⁽¹⁾ x1 + 10 sterile perforators⁽²⁾</p> <hr/> <p>Autoclavable irrigation lines⁽¹⁾ x1</p> <hr/> <p>Disposable sterile perforators⁽²⁾ x10</p>	<p>F57374</p> <hr/> <p>E59920</p> <hr/> <p>F57372</p>
 <p>16 - P-Max Newtron® (Lux) Range II 17 - Prophy Max Newtron® (Lux) Range II</p>			<p>Newtron® double-lines⁽¹⁾ kit x10</p> <hr/> <p>Newtron® single-lines⁽¹⁾ kit x10</p>	<p>F59752</p> <hr/> <p>F59756</p>
 <p>18 - Suni 1st generation</p>			<p>Suni irrigation lines⁽¹⁾ kit x5</p> <hr/> <p>Suni irrigation lines⁽¹⁾ kit x10</p>	<p>F34700</p> <hr/> <p>F34702</p>
 <p>19 - I-Surge™ + 20 - HT-Implant</p>			<p>Irrigation lines⁽¹⁾ x10</p>	<p>F28750</p>

(1) Irrigation set - Class Is medical device (GMED) - CE 0459 - Manufacturer: SATELEC® ACTEON® Group - France
 (2) Class Is medical devices (GMED) - CE 0459 - Manufacturer: SATELEC® ACTEON® Group - France

POLISHERS

.....



ALL-IN-ONE FOR EASY PROCEDURES

air-n-go
easy



All-in-one airpolisher for easy procedures

- Supra and sub-gingival use
- Optimal space
- Ready to use

AIR-N-GO® easy with KaVo* adapter	1.209,70 €	F10100
AIR-N-GO® easy with Sirona* adapter	1.209,70 €	F10101
AIR-N-GO® easy with W&H* adapter	1.209,70 €	F10102
AIR-N-GO® easy with Bien-Air* adapter	1.209,70 €	F10103
AIR-N-GO® easy with Midwest* adapter	1.209,70 €	F10105

with a convertible AIR-N-GO® easy handpiece, a Supra nozzle, 1 AIR-N-GO® easy maintenance kit (replacement o'rings, syringe of silicone grease with brushes, cannula, cleaning drill)

Dental air-polishing handpiece - Class IIa medical device (GMED) - CE 0459 - Manufacturer: SATELEC® ACTEON® Group - France

*KaVo, Sirona, W&H, Bien-Air and Midwest are registered trademarks

Accessories



AIR-N-GO® easy Perio kit⁽¹⁾
turns your handpiece into a Perio system to treat periodontal disease (tooth & implants) on pockets from 3 to 8mm. with a AIR-N-GO® easy nozzle and a bottle of AIR-N-GO® PERIO glycine powder

608,10 € F10120



AIR-N-GO® Supra nozzle
for all prophylaxis supra-gingival treatments

360,10 € F10125



AIR-N-GO® Perio easy nozzle
turns your handpiece into a Perio system to treat non surgical periodontal disease (tooth & implants) in pockets from 3 to 8mm

396,30 € F10126



AIR-N-GO® Perio nozzle
turns your handpiece into a Perio system to treat non surgical periodontal disease (tooth & implants) in pockets from 3 to 8mm

396,30 € F10127



AIR-N-GO® Perio Maintenance nozzle
turns your handpiece into a system adapted for periodontal maintenance in pockets until 4mm

360,10 € F10128



AIR-N-GO® easy maintenance kit

28,50 € F10121

(1) Class IIa medical devices (GMED) - CE 0459 - Manufacturer: SATELEC® ACTEON® Group - France

Adapters



KaVo* Adapter

307,40 €

F10240



Sirona* Adapter

362,20 €

F10241



W&H* Adapter

273,30 €

F10242



Bien-Air* Adapter

273,30 €

F10243



Midwest* Adapter

169,00 €

F10245

Accessories



AIR-N-GO® Supra nozzle

360,10 €

F10125



AIR-N-GO® Supra nozzle

396,30 €

F10127



AIR-N-GO® Perio tank

186,60 €

F10216



AIR-N-GO® Supra probe Ø0.5mm

16,50 €

F10207



AIR-N-GO® Supra probe Ø1mm

27,40 €

F10208



AIR-N-GO® Perio probe

11,00 €

F10206



AIR-N-GO® o'rings kit

67,00 €

F10205



prophymax

Combinated device with ultrasonics and airpolisher

ProphyMax™

4.160,00 €

F11610

with a ProphyPen handpiece with 135° titanium nozzle, an autoclavable universal wrench, a bottle of mint powder (250g) and a bottle of lemon powder (250g), an autoclavable Newtron® handpiece, a double footswitch

Dental polishing and ultrasonic control console

Class IIa medical device (GMED) - CE 0459 - Manufacturer: SATELEC® ACTEON® Group - France

Important

You will find all the information about ultrasonics accessories (tips, handpieces, etc) on pages 106 to 113.



air max

Supra-gingival airpolisher

Air Max

2.720,00 €

F11400

with a ProphyPen handpiece with 135° titanium nozzle, an autoclavable universal wrench, a bottle of mint powder (250g) and a bottle of lemon powder (250g)



Dental polishing control console - Class IIa medical device (GMED) - CE 0459 - Manufacturer: SATELEC® ACTEON® Group - France

Accessories

	Blue ProphyPen⁽¹⁾ Disconnectable polisher handpiece (bayonet) with a 135° titanium nozzle and an autoclavable universal wrench	428,10 €	F10554
	White ProphyPen Disconnectable polisher handpiece (bayonet) with a 135° titanium nozzle and an autoclavable universal wrench	428,10 €	F10557
	Titanium nozzle 135° Ø0.7 mm	80,10 €	F10555
	Probe Ø0.7mm	16,50 €	F10207
	Probe Ø1mm	27,40 €	F10208
	Multifunctions double footswitch	192,10 €	F00055
	2 ProphyPen o-rings + 1 nozzle o-ring kit	7,70 €	F10374

(1) Dental air-polishing handpiece - Class IIa medical device (GMED) - CE 0459 - Manufacturer: SATELEC® ACTEON® Group - France

Powders

	AIR-N-GO® "CLASSIC" powder⁽¹⁾ 4 bottles (250g)		
	Peppermint	92,20 €	F10250
	Lemon	92,20 €	F10251
	Raspberry	92,20 €	F10252
	Cola	92,20 €	F10253
	Neutral	92,20 €	F10254
	AIR-N-GO® "CLASSIC" powder⁽¹⁾ 4 flavors (peppermint, Lemon, Raspberry and cola) 4 bottles (250g)	92,20 €	F10255
	AIR-N-GO® "PERIO" powder⁽²⁾ 3 bottles (160g)	141,60 €	F10270

(1) Class IIa medical device - (GMED) - CE 0459 - Manufacturer: SATELEC® ACTEON® Group - France

(2) Powder for subgingival treatment of periodontitis and peri-implantitis - Class IIa medical device - (GMED) - CE 0459 - Manufacturer: SATELEC® ACTEON® Group - France

CURING LIGHT

.....



FAST CURING, LONG TERM RESULTS



A fast curing for aesthetics result

- Fast and powerful treatment
- Adapted to the act
- Long battery life



miniled
active

Ready to use



miniled
supercharged

Powerful



miniled
ortho 2

Adaptable



miniled
standard

Classic

miniled active



Wavelength: 420 - 480nm

Power: 1492mW/cm²

Li-Ion battery

Handpieces: anodized aluminium

MiniLED™ Active

754,10 €

F05100

with a MiniLED™ handpiece, an universal power supply cord, a Ø7.5mm opalescent guide and an oval light shield

Dental curing light - Class I medical devices - CE - Manufacturer: SATELEC® ACTEON® Group - France

miniled supercharged

Wavelength: 420 - 480nm

Power: 2000mW/cm²

Li-Ion battery

Handpieces: anodized aluminium



MiniLED™ Supercharged

1.164,70 €

F05214

with a MiniLED™ handpiece, a battery, a battery charger, a power supply + 4 plugs, a Ø7.5mm opalescent light guide and light shield

Dental curing light - Class I medical devices - CE - Manufacturer: SATELEC® ACTEON® Group - France

miniled ortho 2

Wavelength: 420 - 480nm

Power: 3000mW/cm²

Li-Ion battery

Handpieces: anodized aluminium



MiniLED™ Ortho 2

1.174,60 €

F05220

with a MiniLED™ handpiece, a Ø5.5mm opalescent guide, a power supply + 4 plugs, a battery, a battery charger and an oval light shield

Dental curing light - Class I medical devices - CE - Manufacturer: SATELEC® ACTEON® Group - France

miniled standard

Wavelength: 420 - 480nm

Power: 1250mW/cm²

Li-Ion battery

Handpieces: anodized aluminium



MiniLED™ Standard

923,20 €

F02507

with a MiniLED™ handpiece, a battery, a battery charger, a power supply cord with european plug, a Ø7.5mm opalescent guide and an oval light shield

Dental curing light - Class I medical devices - CE - Manufacturer: SATELEC® ACTEON® Group - France

Accessories

MiniLED™ Supercharged handpiece⁽¹⁾	1.114,20 €	F05217
MiniLED™ Ortho 2 handpiece⁽¹⁾	1.114,20 €	F05219
MiniLED™ Standard handpiece⁽¹⁾	653,10 €	F02530
 Charger for MiniLED™ Supercharged, MiniLED™ Ortho2 and MiniLED™ Autofocus2	478,60 €	F02917
Charger for MiniLED™ MiniLED™ Standard	462,10 €	F02510
 Titanium battery for MiniLED™ Supercharged, MiniLED™ Ortho2 and MiniLED™ Autofocus2	213,00 €	F05211
Titanium battery for MiniLED™ Standard	174,50 €	F02520
 Oval light shield for MiniLED™ Active, MiniLED Ortho2, MiniLED™ Supercharged and MiniLED™ Autofocus2	53,80 €	F05407
 Oval light shield for MiniLED™ Standard	40,60 €	F02555

Accessories

	Universal power supply for MiniLED™ Active	52,70 €	F05120
	Universal power supply for MiniLED™ Supercharged, MiniLED™ Ortho2 and MiniLED™ Autofocus2	107,60 €	F05216
	European power supply for MiniLED™ Standard	92,20 €	F02543
	Opalescent light guide Ø7.5mm for MiniLED™ Active	163,60 €	F05121
	Opalescent light guide Ø7.5mm for MiniLED™ Standard, MiniLED™ Ortho2 and MiniLED™ Supercharged	148,20 €	F02648
	Opalescent light guide Ø5.5mm for MiniLED™ Standard, MiniLED™ Ortho2 and MiniLED™ Supercharged	148,20 €	F02652

	Autoclavable caps Ø7.5mm x5 for MiniLED™ Standard, MiniLED™ Ortho2, MiniLED™ Supercharged and MiniLED™ Autofocus2	42,80 €	F61507
	Autoclavable caps Ø5.5mm x5 for MiniLED™ Standard, MiniLED™ Ortho2, MiniLED™ Supercharged and MiniLED™ Autofocus2	42,80 €	F61505
	Autoclavable caps Ø7.5mm x5 Autoclavable caps Ø5.5mm x5 for MiniLED™ Standard, MiniLED™ Ortho2, MiniLED™ Supercharged and MiniLED™ Autofocus2	49,40 €	F61515

MISCELLANEOUS

.....



softly



Amalgamator

Pre-measured capsules amalgamator

External dimensions:

210 x 205 x 120mm (D x W x P)

Weight: 3.1kg

Softly

417,10 € 6.01.00112



ACTEON®
INSTRUMENTS

BLISS RANGE

.....

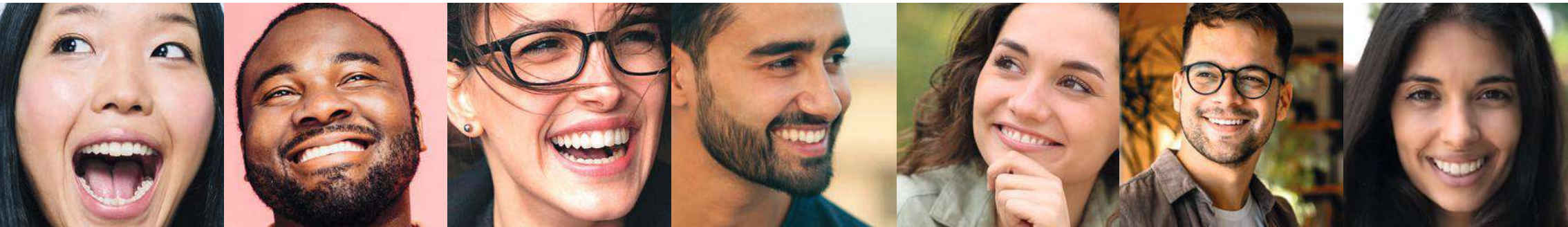



bliss

SUPERIOR COMFORT AT YOUR FINGERTIPS

The next generation of manual instrumentation

- Lightweight: 15g
- Unique "Soft Touch" grip
- Long lasting sharpness⁽¹⁾
- 100% approved by practitioners⁽²⁾

UNCONVENTIONALLY DURABLE AND SOLID

- High wear-resistance due to the stainless steel properties
- The metal is treated in accordance with the latest heating techniques

ENHANCED COMFORT THE FINAL GOAL

- High sharpness means less force
- Less force means less muscle fatigue
- Less force means comfortable scaling

Manual instrumentation video



TRUE ERGONOMICS

- 10mm: optimal handle diameter to reduce pinch force⁽³⁾
- 15g: ultra light to limit hand fatigue⁽³⁾

UNIQUE COMFORT

- Flat areas for the fingers, to avoid localized pressure
- Intrinsic tactile sensation

GENTLE AND CONFIDENT GRIP

- Effective «soft touch» non-slip surface
- Firm silicone with no spring effect for an accurate and controlled clinical gesture

REVOLUTIONARY COMFORT AT YOUR FINGERTIPS

39 instruments

- Diagnostic
- Restoration
- Periodontics
- Endodontics
- Prophylaxis



(1) The effects of periodontal instrument handle on hand muscle load and pinch force, D. Rempel; D. Lee; K. Dawson; P. Loomer; JADA 143 (10) - October 2012.

(2) Internal field evaluation on 20 practitioners from 8 different countries. 100% answered that Bliss handle was comfortable.

(3) Rempel D, Lee D.L., Dawson K, Loomer P. The effects of periodontal curette handle weight and diameter on arm pain. JADA. 2012 Oct;143(10)

Kits

Every consultation starts with these 3 instruments

One end of the handle is flat to facilitate percussive diagnostics, allowing to evaluate the sensitivity and the mobility of the tooth and the sensitivity of the gum.



Diagnostic kit Bliss®

with an Easy Clip cassette, 1 EXP17-23,
1 College tweezers 15cm satin finishing
mirror handle SS + 1 PureReflect® mirror
mirror handle CSS + 1 PureReflect® mirror

402SS.SI
402CSS.SI



Care kit Bliss®

with an Easy Clip cassette, 1 EXP17-23,
1 CMS2, 1 College tweezers 15cm satin
finishing
mirror handle SS + 1 PureReflect® mirror
mirror handle CSS + 1 PureReflect® mirror

403SS.SI
403CSS.SI

The design is accurate and thin, ideal to draw furrows and cuspids. The ergonomic and unique design of Bliss® handle offer comfort and precision of the clinical gesture.

This is essential for restoration work when modelling and sculpting the composite.



Restoration kit Bliss®

with an Easy Clip cassette, 1 EXP17-23,
1 CMS4, 1 CMS2, 1 BUR125,
1 EXC38-37, 1 EXC91, 1 College tweezers
15cm satin finishing
mirror handle SS + 1 PureReflect® mirror
mirror handle CSS + 1 PureReflect® mirror

404SS.SI
404CSS.SI

The high wear resistance combined with the optimal hardness of the metallic blade make the sharp instruments efficient and long-lasting.



Prophylaxis kit Bliss®

with an Easy Clip cassette, 1 UNC12,
1 M23, Gracey curettes 11-12 and 13-14,
1 H6-H7, 1 Columbia curette 13-14
mirror handle SS + 1 PureReflect® mirror
mirror handle CSS + 1 PureReflect® mirror

400SS.SI
400CSS.SI

It includes 11 manual instruments covering most of orthograde endodontic procedures and conservative dentistry: cleaning the cavity, obturation of the access cavity, reprocessing and restoration.



Endodontic kit Bliss®

with a cassette, 1 Self-Blocking tweezers,
1 CP15, 1 EX37-38, 1 EX91, 1 SP25,
1 CMS6, 1 Machtou 1-1, 1 Machtou 1-2,
1 Machtou 2-3, 1 Machtou 2-4, 1 endo files
holder
mirror handle SS + 1 PureReflect® mirror
mirror handle CSS + 1 PureReflect® mirror

401SS.SI
401CSS.SI

Gracey curettes



Gracey curette 1-2

402.01SI



Gracey curette 3-4

402.03SI



Gracey curette 5-6

402.05SI



Gracey curette 11-12

402.11SI



Gracey curette 13-14

402.13SI



Gracey curette 15-16

402.15SI



Gracey curette 17-18

402.17SI

Sickles



Sickle - M23

404.23SI



Sickle - H6-H7

406.07SI



Micro CK6

404.05SI

Universal curettes



Universal curette - Barnhart 5-6

408.05SI



Universal curette - Columbia 4L-4R

405.04SI



Universal curette - Columbia 13-14

405.13SI



Universal curette - Langer 5-6

406.06SI



Universal curette - Langer 5-6 mini

406.10SI

Dual ends



Dual End - H5-L5

406.05SI



Dual End - N128-L5

406.08SI



Dual End - N128-L5 mini

406.09SI

Diagnostics



EXP11-12 - Explorer

263.06SI



EXP17-23 - Explorer

263.07SI

Periodontics



UNC12 graduated 1 to 12mm - Expro

418.06SI



CP12 graduated 3-6-9-12mm - Expro

418.07SI



UNC15 graduated 1 to 15mm - Expro

418.08SI



CP12 graduated 3-6-9-12-15mm - Expro

418.09SI

Restoration



EXC36-35 - Excavator

165.01SI



EXC38-37 - Excavator

165.02SI



EXC91 - Excavator

165.03SI



BUR125 - Burnisher

108.14SI



CM1 - Modeling spatula

194.12SI



CM2 - Modeling spatula

194.13SI



CM3 L4/5.4mm - Modeling spatula

194.14SI



CM4 L4/5.6mm - Modeling spatula

194.15SI



CM5 L1.6/1.6mm - Modeling spatula

194.16SI



CM6 L1.6/1.6mm for molars - Modeling spatula

192.05SI

Restoration



SP20 20mm - Cement spatula

246.05SI



SP25 25mm - Cement spatula

246.09SI



SP42 42mm - Cement spatula

246.24SI

Endodontics



Machtou 1-1 - Plugger

419.01SI



Machtou 1-2 - Plugger

419.02SI



Machtou 2-3 - Plugger

419.03SI



Machtou 2-4 - Plugger

419.04SI

Mirror handle



Mirror handle EU stem*
Mirror handle CSS*

210.00SI
212.00SI

* mirror sold separately - Pure Reflect size 5: MP4624PH (CSS) - MP3624PH (EU Stem)



MIRROR RANGE

.....

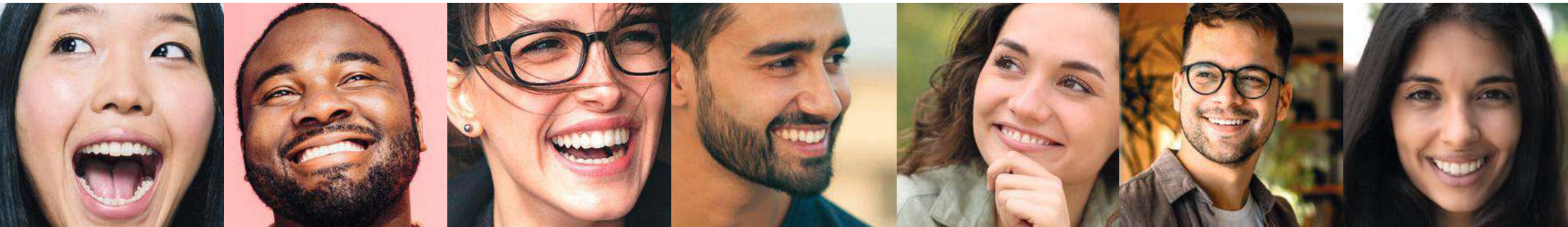

PERFECT CLARITY, CRYSTAL-CLEAR VISION

MOUTH MIRRORS - FROM DIAGNOSTIC TO TREATMENT, THE BENEFIT TO ALL DENTAL CLINICAL ACTS



- Visual examination is the first step to diagnostics
- 10 different sizes
 - From 0 to 6 to work in the mouth
 - From 7 to 10 to clinical studies, photography

MICROMIRRORS - THE MICROSCOPIC PERFECTLY VISIBLE



- Make the access to the apex easier and appreciate the accurate vision of the pulp chamber.
- 4 different sizes

PHOTOGRAPHIC MIRRORS - EFFECTIVE COMMUNICATION WITH PATIENTS



- Highlight the dental treatment and restoration to promote the practice. Allow to take pictures of clinical cases for books, publications and patient records.
- 8 different sizes for occlusal, vestibular and lingual areas.

Our mirrors resist to more than 100 autoclave cleaning cycles*



Mirrors has to be replaced after 3 MONTHS of daily use

Front surface

Cross-sectional view

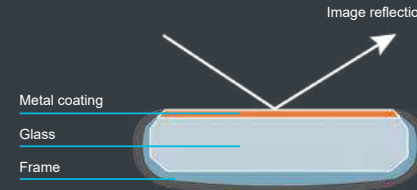
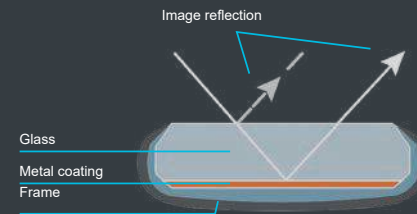

Image reflected directly on the surface of the glass, distortion-free
NO DOUBLE IMAGE

Back surface

Cross-sectional view of an aluminium mirror



Reflecting surface under the glass
DOUBLE IMAGE



The finition of the frame also matters

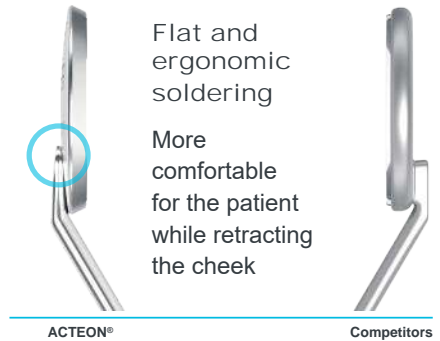

Flat and ergonomic soldering
More comfortable for the patient while retracting the cheek





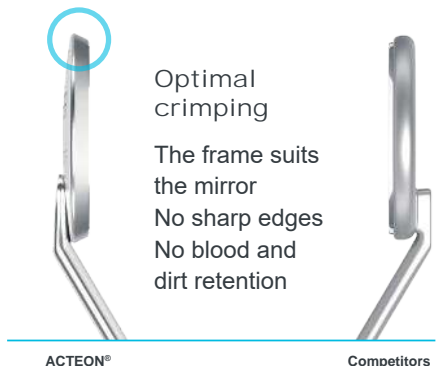



Satined finition

Prevent light reflection in the eyes
Avoid eye fatigue



Optimal crimping
The frame suits the mirror
No sharp edges
No blood and dirt retention

Mouth mirrors simple stem







 Ø14mm	n.0 Plan mirror	Pure Reflect® mirror - x12	101,00 €	MP3614PH
 Ø16mm	n.1 Plan mirror	Pure Reflect® mirror - x12	101,00 €	MP3616PH
 Ø18mm	n.2 Plan mirror	RH mirror - x12 Pure Reflect® mirror - x12	61,50 € 101,00 €	MP3318PH MP3618PH
 Ø20mm	n.3 Plan mirror	Alu mirror - x12 RH mirror - x12 Pure Reflect® mirror - x12	32,90 € 53,80 € 93,30 €	MP3120PH MP3320PH MP3620PH
 Ø22mm	n.4 Plan mirror	Alu mirror - x12 Alu mirror - x20 RH mirror - x12 Pure Reflect® mirror - x12	19,80 € 34,00 € 41,70 € 53,80 €	MP3122PH MPV3122PH MP3322PH MP3622PH
 Ø24mm	n.5 Plan mirror	Alu mirror - x12 Alu mirror - x20 RH mirror - x12 Pure Reflect® mirror - x12	19,80 € 34,00 € 41,70 € 53,80 €	MP3124PH MPV3124PH MP3324PH MP3624PH
 Ø26mm	n.6 Plan mirror	Alu mirror - x12 RH mirror - x12 Pure Reflect® mirror - x12	34,00 € 65,90 € 105,40 €	MP3126PH MP3326PH MP3626PH
 Ø28mm	n.7 Plan mirror	Alu mirror - x1 Pure Reflect® mirror - x1	990,00 € 26,30 €	MP3128PH MP3628PH

 Ø30mm	n.8 Plan mirror	Alu mirror - x1 RH mirror - x1 Pure Reflect® mirror - x1	11,00 € 19,80 € 27,40 €	MP3130PH MP3330PH MP3630PH
 Ø40mm	n.9 Plan mirror	Alu mirror - x1 RH mirror - x1 Pure Reflect® mirror - x1	11,00 € 23,10 € 29,60 €	MP3140PH MP3340PH MP3640PH
 Ø50mm	n.10 Plan mirror	Alu mirror - x1 Pure Reflect® mirror - x1	12,10 € 36,20 €	MP3155PH MP3655PH
	n.4 Double sided mirror	RH mirror - x12 RH mirror - x6 Pure Reflect® mirror - x12 Pure Reflect® mirror - x6	119,70 € 67,00 € 147,10 € 82,30 €	MP7322PH MP7422PH MP7822PH MP7722PH
	n.5 Double sided mirror	RH mirror - x12 RH mirror - x6 Pure Reflect® mirror - x12	119,70 € 67,00 € 147,10 €	MP7324PH MP7424PH MP7824PH
 Ø22mm	n.4 Magnifying mouth mirror x3.5	Alu mirror - x12	30,70 €	MP3222PH
 Ø24mm	n.5 Magnifying mouth mirror x3.5	Alu mirror - x12	31,80 €	MP3224PH

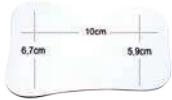
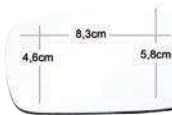
Micromirrors

	Pure Reflect® Micromirror SS Ø3mm - round	82,30 €	MP3303PH
	Pure Reflect® Micromirror SS Ø5mm - round	82,30 €	MP3305PH
	Pure Reflect® Micromirror SS 7x2mm - rectangular	88,90 €	MP3306RPH
	Pure Reflect® Micromirror SS 9x3mm - rectangular	88,90 €	MP3310RPH
	Pure Reflect® Micromirror Ø3mm - 14.8cm - round	76,80 €	MP1303PH
	Pure Reflect® Micromirror Ø5mm - 14.8cm - round	76,80 €	MP1305PH
	Pure Reflect® Micromirror 7x2mm - 14.8cm - rectangular	88,90 €	MP1306RPH
	Pure Reflect® Micromirror 9x3mm - 14.8cm - rectangular	88,90 €	MP1310RPH

Photographic mirrors

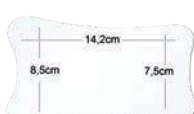
	Occlusal surface adult	TI coating Chromium coating Pure Reflect® coating	77,90 € 56,00 € 110,90 €	MZP511. MZP512. MZP516.
	Occlusal surface child	TI coating Chromium coating Pure Reflect® coating	77,90 € 56,00 € 110,90 €	MZP521. MZP522. MZP526.
	Vestibular surface	TI coating Chromium coating Pure Reflect® coating	77,90 € 56,00 € 110,90 €	MZP531. MZP532. MZP536.
	Thin lingual surface	TI coating Chromium coating Pure Reflect® coating	77,90 € 56,00 € 110,90 €	MZP541. MZP542. MZP546.
	Large lingual surface	TI coating Chromium coating Pure Reflect® coating	77,90 € 56,00 € 110,90 €	MZP551. MZP552. MZP556.
	Lateral shape	TI coating Chromium coating Pure Reflect® coating	77,90 € 56,00 € 110,90 €	MZP561. MZP562. MZP566.
	Large occlusal surface	TI coating Chromium coating Pure Reflect® coating	77,90 € 56,00 € 110,90 €	MZP571. MZP572. MZP576.
	Extra large occlusal surface	TI coating Chromium coating Pure Reflect® coating	77,90 € 56,00 € 110,90 €	MZP581. MZP582. MZP586.

Contrastors



Contrastor n.4 small straight design
240x60x1.5mm

26,30 €

MZP215

Contrastor n.5 large straight design
240x60x1.5mm

26,30 €

MZP216

Contrastor n.3
73x70mm

26,30 €

MZP217

Contrastor n.1
84x85mm angular

26,30 €

MZP218

Contrastor n.2
59x70mm angular

26,30 €

MZP219

Accessories



XLstyle
handle

XLStyle mirror handle EU stem

12,10 €

210.00XL

Design
handle

Design mirror handle EU stem

6,60 €

210.00D

Rotating holder for photographic mirrors

72,40 €

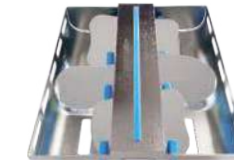
MZP214.

Sterilization tray for photographic mirrors
for 3 photographic mirrors
or 2 photographic mirrors + 1 handle
(sold empty)

157,00 €

233.19

Anti-mist solution for mirrors 100ml
Anti-mist solution for mirrors 30ml

22,00 €

ABF
AB30

ACTEON®
CONSUMABLES



PROSTHETICS

.....



expasyl exact



expasyl



ENHANCE YOUR IMPRESSION ACCURACY

A TRIPLE ACTION

1 ASTRINGENT EFFECT

helps to completely dry the sulcus with no blood or fluids.

2 OPEN THE SULCUS

effectively with no pain or damage to tissues thanks to the viscosity carefully calculated with our clinical expertise.

3 PRESERVE EPITHELIAL ATTACHMENT*

for a reduced risk of gingival recession and bone resorption.

* Canula must not be inserted into the sulcus

EXPASYL™ PASTE USED BY EXPERTS

97% of Expasyl™ paste users would recommend this product to a colleague*

93% of Expasyl™ paste users say that the sulcular opening obtained with the product is ideal for impression taking*

94% of Expasyl™ paste users find that the application is very easy*

WHY CHOOSE EXPASYL™ RETRACTION PASTE?

Compared to traditional cords, Expasyl™ paste preserves gingival tissues and epithelial attachment.⁽¹⁾

Expasyl™ paste generates pressure 1.7 to 9.2 times greater than other retraction paste available on the market.⁽²⁾

ENSURE COMPLETE SUCCESS OF YOUR PROSTHETIC RESTORATIONS

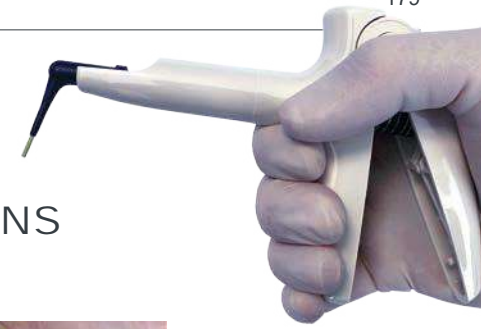

Dr Erwan BOULIC
Dentist - France

Expasyl™ paste allows full access to emergence profile to guarantee the most natural finish



EASILY APPLIED
20 SECONDS

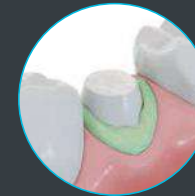

WORKS IN
1-2 MINUTES
max



EASILY REMOVED
with a gentle
air/water spray



(1) Bennani V, Aarts JM, He LH. A comparison of pressure generated by cordless gingival displacement techniques. J Prosthet Dent. 2012 June;107(6):388-92.

(2) Klettke T, Schulte C. Force required to displace Pastes and gels for Gingival retraction. 2012 AADR Annual Meeting (Tampa, Florida) – Poster Session ID 1364.

Expasyl™ Exact



Expasyl™ Exact x 50 322,40 € 261 011

Expasyl™ Exact x 20 141,70 € 261 010



Universal applicator gun 111,50 € 260 920

Expasyl™



Expasyl™ Minikit
with 6 capsules + 12 straight cannulas
+ 1 applicator 388,50 € 294 100



Capsule strawberry flavour x 20 204,50 € 261 001

Capsule x 20 193,70 € 261 030



Bent cannulas x 40 60,60 € 261 045

Bent cannulas x 100 92,00 € 261 015



Straight cannulas x 40 56,30 € 261 040

Straight cannulas x 100 82,20 € 261 005



Manual applicator 411,20 € 260 900

cav-hycal

Light-curing, radiopaque one-component
material containing calcium hydroxide



Indications

- Indirect pulp capping

- Cavity liner

Properties

- One-component material

- Radiopaque.

- High compressive and tensile strength

Cav-Hycal™

2 x 2ml syringes and 20 disposable tips

85,60 € 213 876

Class IIa medical device (MEDCERT) - CE 0482 - Manufacturer: MP Medical Product - Germany
Distributed by: PRODUITS DENTAIRE PIERRE ROLLAND ACTEON® Group - France

ENDODONTICS

.....



Aesthetics restoration

cav-hycal

Light-curing, radiopaque one-component material containing calcium hydroxide



Indications

- Indirect pulp capping
- Cavity liner

Properties

- One-component material
- Radiopaque.
- High compressive and tensile strength

Cav-Hycal™

2 x 2ml syringes and 20 disposable tips

85,60 €

213 876

Class IIa medical device (MEDCERT) - CE 0482 - Manufacturer: MP Medical Product - Germany
Distributed by: PRODUITS DENTAIRE PIERRE ROLLAND ACTEON® Group - France

MTA caps

Endodontic repair cement

Indications

- Root end filling (retrograde)
- Repair of root perforations during root canal therapy
- Pulp capping
- Root end filling (orthograde)

Properties

- Biocompatible
- Barrier impervious to bacteria and fluids
- Radiopaque
- Easy to use
- Delivered under single-use capsules



MTA* CAPS⁽¹⁾

1 aluminium bag with 2 pre-proportioned 0.3g-capsules

102,10 €

251 170

MTA* Appli caps⁽²⁾

101,00 €

213 675

(1) Class IIa medical device (MEDCERT) - CE 0482

(2) Class I medical device - CE - Manufacturer: First Scientific Dental GmbH - Germany

Distributed by: PRODUITS DENTAIRE PIERRE ROLLAND ACTEON® Group - France

* Mineral Trioxide Aggregate

hycal

Ready-to-use calcium hydroxide paste

Indications

Hycal™ is a calcium hydroxide paste indicated for application:

- Direct capping when pulp opened or after pulpotomy.
- Indirect capping for treatment of deep caries.
- Lining of cavities to prevent exposure to acid media when using cements
- Temporary filling of root-canals.

Properties

- Product ready to use.
- High pH (>12.5)
- Effective protection of the pulp.
- Formation of tertiary dentin.
- Radio-opaque.

HYCAL™

1 x 2ml syringe and 5 additional bended application cannulas

62,60 €

259 314



Class IIa medical device (MEDCERT) - CE 0482 - Manufacturer: MP Medical Product - Germany
Distributed by: PRODUITS DENTAIRE PIERRE ROLLAND ACTEON® Group - France

sealite regular

Powder and liquid for permanent sealing cement for root canals

Properties

Cement allows the tooth to remain functional.

Forms an easy-to-apply, tight (very low solubility and disintegration after setting, in compliance with ISO 6876:2012), radiopaque cement with a homogeneous consistency.

Must be used with gutta percha cones.

Composition

- Sealite™ Regular powder: Diiodothymol - Zinc oxide - Radio-opacifier - Excipients
- Sealite™ Liquide: Eugenol - Excipients

Sealite™ Regular kit

25g of Sealite™ Regular Powder⁽¹⁾, 10ml of Sealite™ Liquide⁽¹⁾,
1 spoon⁽²⁾, 1 dropper⁽²⁾

126,20 € 266 264

Sealite™ Liquide⁽¹⁾

10ml (refill)

38,40 € 266 267

(1) Class IIa medical device (GMED) - CE 0459

(2) Class I medical device - CE

Manufacturer: PRODUITS DENTAIRE PIERRE ROLLAND ACTEON® Group - France



eugenol pur

Liquid for zinc-oxide based cement

Properties

The eugenol confronted with bivalent metallic ions (Zn²⁺) forms a chelate: chemopolymerization.

To be used with Cortisolom™ SP powder.

Composition

Eugenol 100%

Eugenol Pur

60ml bottle

51,60 € 234 110

Class IIa medical device (GMED) - CE 0459 - Manufacturer: PRODUITS DENTAIRE PIERRE ROLLAND ACTEON® Group - France



cimavit

Zinc oxide-based temporary filling cement

Properties

- Ready-to-use (no mixing)
- Waterproof
- Very good adherence to dentine
- Immediate setting time in mouth
- Easy to remove (probe, excavator, ...)
- Pink colour for a good contrast

Cimavit™

6 x 28g jars

76,80 € 213 859

Class IIa medical device (TUV Rheinland) - CE 0197 - Manufacturer: G-Pharma - France
Distributed by: PRODUITS DENTAIRE PIERRE ROLLAND ACTEON® Group - France



cimavit photo

Light-curing filling material for temporary restorations

Indications

All types of temporary fillings, temporary protection in inlay and onlay techniques

Properties

Ready-to-use material, does not stick to instruments, condensable, does not require a particular finishing of the cavity, ensures a hermetic seal (isolates the tooth from bacterial and thermal aggression).

In case of more than two weeks' stay in mouth, and in occlusal or marginal areas, reinforcement with composite is recommended.

Good aesthetic translucency. Its elastic consistency facilitates its removal in one bloc.

Cimavit™ Photo

2 x 4g syringes

67,00 € 213 830

Class IIa medical device (MEDCERT) - CE 0482 - Manufacturer: MP Medical Product - Germany
Distributed by: PRODUITS DENTAIRE PIERRE ROLLAND ACTEON® Group - France



PROPHYLAXIS & PERIODONTICS

.....



etik collagene

Hemostatic surgical dressing

Properties

Collagen is a fibrillar protein naturally present in all connective tissues. Lyophilized collagen in cylindrical form displays hemostatic activity due to its adhesive power, liquid absorption and gelification properties. The collagen cylinder moulds itself into the hemorrhagic surface where it adheres strongly upon mechanical compression, thus promoting the formation and maintenance of a platelet clot (coagulation). The collagen cylinders are resorbable.

Composition

Native, non-denatured, lyophilized bovine collagen (mainly type I collagen): 100%. This device contains tissues of animal origin under regulation (EU) no. 722/2012. Dimensions: diameter ≈ 10mm, height ≈ 16mm



Etik™ Collagene

25 unit-packaged sterile cylinders (in blister packs)

87,80 € **281 970**

Class III medical device (GMED) - CE 0459 - Manufacturer: PRODUITS DENTAIREs PIERRE ROLLAND ACTEON® Group - France

hemostasyl

Hemostatic surgical dressing

Indication

To be used in all cases of moderate bleeding occurring in routine dental practice (scaling, etc.)

Properties

- Thixotropic properties
- Good adhesion to the gingival mucosa, without compression
- Presence of aluminum chloride which reinforces its mechanical haemostatic effect
- Placed directly in the mouth with the single-use angled cannula
- Easily located due to its color
- Easily removed by gentle water spray without resumption of bleeding
- Painless on a healthy periodontium
- Contact time: 2 minutes max.



Hemostasyl™ kit

2 x 2g-syringes⁽¹⁾ + 40 cannulas⁽²⁾

86,70 € **246 200**

Hemostasyl™ seringues

2 x 2g-syringes⁽¹⁾

71,40 € **246 050**

Hemostasyl™ cannulas⁽²⁾ x 40

19,80 € **246 100**

(1) Class IIa medical device (GMED) - CE 0459

(2) Class I medical device - CE - Manufacturer: PRODUITS DENTAIREs PIERRE ROLLAND ACTEON® Group - France

sitsalicine

Polishing teeth after scaling

Properties

Silica is a mildly abrasive powder which gives the paste its polishing properties, eliminating the micro-roughness that is present after scaling, without damaging the enamel or gums. A flavouring compound gives its pleasant, refreshing taste.



Sitsalicine™

60g tube

49,40 € **277 803**

Class IIa medical device (GMED) - CE 0459 - Manufacturer: PRODUITS DENTAIREs PIERRE ROLLAND ACTEON® Group - France

HYGIENE

.....



METALLIC TIPS

DID YOU KNOW?

It is impossible to clean correctly the inside of reusable tips due to the presence of biofilm.⁽¹⁾



Metallic tip after 1 year use

- Not effective cleaning of reusable tips in the long-term.
- Hygiene maintenance takes time between two patients.



With regard to cleaning and sterilization, disposable tips were found to be more acceptable in clinical use than metal tips.⁽¹⁾

(1) M. Inger, V. Bennani, M. Farella, F. Bennani, R.D. Cannon. Efficacy of air/water syringe tip sterilization. Australian Dental Journal 2014; 59: 87-92 - R. Puttaiah et al. Rationale for using single-use disposable air/water syringe tips. Compendium. 1999;20(11):1056-1069

riskontrol

Disposable tips

YOUR DAILY ROUTINE



- Save time & money
- Ensure your clinical protection
- Protect your patient
- Meet your expectations for your different procedures
- Reach easily difficult-to-access areas
- Avoid risk of ingestion

(2) ML Silva, M. Zumpe, J. Lespinasse, M. Aulois-Griot. Cost comparison of reusable and disposable air/water syringe tips in a large French teaching hospital. Swiss Dental Journal 2017

universal solution

Match with your air/water syringe

RISKONTROL® adapters are available for more than 150 types of dental chairs.

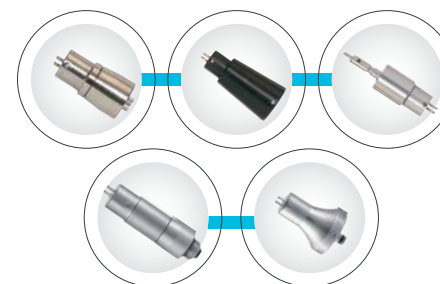

Easy to fit

1



It's installed.

2



It's fitted.

3



It's locked.

Find the adapter that matches perfectly with your equipment in our adapters guide

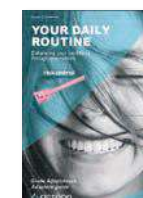

Adapters guide





art
by riskontrol

	Non sterile orange/mandarine tips x 250	57,10 €	201 701
	Non sterile grey/liquorice tips x 250	57,10 €	201 702
	Non sterile green/anise tips x 250	57,10 €	201 703
	Non sterile purple/black currant tips x 250	57,10 €	201 704
	Non sterile white/mint tips x 250	57,10 €	201 700



total protec
by riskontrol

	Non sterile white tips x 100 - with plastic sheath	32,90 €	201 751
	Non sterile blue tips x 100 - with plastic sheath	32,90 €	201 750



classic
by riskontrol

	Non sterile white tips x 250	57,10 €	201 664
	Non sterile blue tips x 250	57,10 €	201 665
	Non sterile yellow tips x 250	57,10 €	201 666
	Non sterile green tips x 250	57,10 €	201 667
	Non sterile pink tips x 250	57,10 €	201 668

Class I medical devices - CE - Manufacturer: PRODUITS DENTAIRE PIERRE ROLLAND ACTEON® Group - France



sterile
by riskontrol

	Tips under individual blisters x 96 - sterilized with ethylene oxide	37,80 €	201 770
---	--	----------------	----------------

Class Is medical device (GMED) - CE 0459 - Manufacturer: PRODUITS DENTAIRE PIERRE ROLLAND ACTEON® Group - France





















Adapters for air/water syringe





















The Riskontrol® range includes different adapters able to equip about a large number of dental chairs.

The adapter is left permanently in place. You just need to change the tips between each patient.

The adapters are delivered with 1 protective cap and, depending on the types, with a replacement O-ring to ensure optimal functioning of your syringe.

Contact your area dealer to determine the correct adapter for your dental chair.

ADEC INOX (NV) 	200 195 111,50 €	ADEC NEW (NV) 	200 205 111,50 €
BELMONT NEW (NV) 	200 158 111,50 €	CAS INOX (NV) 	200 198 111,50 €
CASTELLINI LOGO NEW (NV) 	200 194 111,50 €	CASTELLINI V (NV) 	200 163 111,50 €
CEFLA INOX (NV) 	200 197 111,50 €	D.C.I. (NV) 	200 152 111,50 €
DENTALEZ (NV) 	200 164 111,50 €	ENGLE (NV) 	200 194 111,50 €
FA E (NV) 	200 165 129,80 €	FA E2 (NV) 	200 166 135,80 €
FA C (NV) 	200 167 111,50 €	FA C2 (NV) 	200 168 111,50 €
FA S1 (NV) 	200 182 111,50 €	FLEX (NV) 	200 169 111,50 €
GNATUS INOX (NV) 	200 149 111,50 €	KAVO C (NV) 	200 171 111,50 €
KAVO E (NV) 	200 172 111,50 €	KAVO GB (NV) 	200 156 162,30 €

KAVO HB (NV) 	200 153 111,50 €	KAVO IB (NV) 	200 192 200,20 €
KAVO J (NV) 	200 181 111,50 €	KAVO K (NV) 	200 160 111,50 €
LU INOX (NV) 	200 150 111,50 €	LU V (NV) 	200 173 111,50 €
LU NEW INOX (NV) 	200 199 111,50 €	MORITA 66 TYPE 2 (NV) 	200 159 119,00 €
MORITA INOX WS10 (NV) 	200 201 162,30 €	MORITA INOX WS97 (NV) 	200 200 111,50 €
MORITA S12 (NV) 	200 183 162,30 €	RITTER TOP JET (NV) 	200 176 111,50 €
RITTER COMBIJET (NV) 	200 175 111,50 €	SIEMENS 2000 (NV) 	200 177 111,50 €
SIEMENS 4000 (NV) 	200 178 111,50 €	SIRONA B (NV) 	200 154 111,50 €
SIRONA L (NV) 	200 196 189,40 €	TRIDAC II (NV) 	200 190 111,50 €
YOSHIDA 3 (NV) 	200 193 111,50 €	YOSHIDA V (NV) 	200 180 111,50 €



ACTEON®
OEM

ULTRASONICS

.....



sp newtron



60x50x33mm
28-36kHz
0.1 to 12W
Supply Voltage: 24Vac / 30VA; 34Vdc
Settings: analog or digital



SP Newtron® 4K 5V Module
with connectors

F55297



SP Newtron® 4K 5V Module
with wires

F55298



SP Newtron® 4K3 7V Module
with US special connection

F55287

Class IIa medical device (GMED) - CE 0459 - Manufacturer: SATELEC® ACTEON® Group - France



Light grey

Medium grey

Dark grey

Surf 6 grey

SP Newtron® kits

SP Newtron® 4K 5V with light grey cord				F55292
Cord F00195 Ø4x6 / Length 2070mm	Handpiece F12281	Potentiometer F00524	Tips 1, 2, 10P	
SP Newtron® 4K 5V with light grey cord and connectors				F55349
Cord F00239 Ø6x8 / Length 2070mm	Handpiece F12281	Potentiometer F00524	Tips 1, 2, 10P	
SP Newtron® 4K 5V with dark grey cord				F55311
Cord F00426 Ø7x10 / Length 1500mm	Handpiece F12281	Potentiometer F00524	Tips 1, 2, 10P	
SP Newtron® 4K 5V with dark grey cord				F55375
Cord F00187 Ø4x6 / Length 2300mm	Handpiece F12281	Tips 1, 2, 10P		
SP Newtron® Slim B.LED handpiece with light grey cord				F56260
Cord F00426 Ø4.5x5.6 / Length 2080mm	Handpiece F12905	Potentiometer F00522	Tips 1, 2, 10P	
SP Newtron® Slim B.LED handpiece with medium grey cord				F56262
Cord F01201 Ø4.5x5.6 / Length 2080mm	Handpiece F12905	Potentiometer F00522	Tips 1, 2, 10P	
SP Newtron® with light grey cord				F55299
Cord F00239 Ø6x8 / Length 2070mm	Handpiece F12281	Potentiometer F00524	Tips 1, 2, 10P	
SP Newtron® INTL 81" G3 with medium cord				F55383
Cord F01154 Ø5x7 / Length 1900mm	Handpiece F12281	Tips 1, 2, 10P		
SP Newtron® INTL 61" G3 with medium cord				F55385
Cord F011543 Ø5x7 / Length 1400mm	Handpiece F12281	Tips 1, 2, 10P		
SP Newtron® INTL 81" G3 with medium cord				F55453
Cord F01154 Ø5x7 / Length 1900mm	Handpiece F12281	Potentiometer F00523	Tips 1, 2, 10P	
SP Newtron® with dark grey cord				F55372
Cord F00150 Ø4x6 / Length 2300mm	Handpiece F12281	Tips 1, 2, 10P		
SP Newtron® INTL 61" with Surf 6 grey cord				F55285
Cord F00184 Ø5x7 / Length 1400mm	Handpiece F12281	Tips 1, 2, 10P		
SP Newtron® INTL 81" with Surf 6 grey cord				F55452
Cord F00188 Ø5x7 / Length 1900mm	Handpiece F12281	Potentiometer F00525	Tips 1, 2, 10P	
SP Newtron® 4K 5V with Surf 6 grey cord				F56274
Cord F01181 Ø5x7 / Length 2300mm	Handpiece F12281	Potentiometer E51745	Tips 1, 2, 10P	

sp newtron led



75x49x33mm
 28-36kHz
 0.1 to 12W
 Supply Voltage: 24Vac / 30VA; 34Vdc
 Settings: analog or digital



SP Newtron® LED 4K 5V Module
with connectors

F55527



SP Newtron® LED 4K 5V Module
with wires

F55528



SP Newtron® LED4K3 7V Module
with US special connection

F55529

Class IIa medical device (GMED) - CE 0459 - Manufacturer: SATELEC® ACTEON® Group - France



SP Newtron® LED kits

SP Newtron® LED 4K 5V with light grey cord **F55506**

Cord F00606 Ø5x7 / Length 2070mm	Handpiece F12609	Potentiometer F00524	Tips 1, 2, 10P
-------------------------------------	---------------------	-------------------------	-------------------

SP Newtron® LED 4K 5V with light grey cord **F55543**

Cord F00614 Ø6x8 / Length 2070mm	Handpiece F12609	Potentiometer F00524	Tips 1, 2, 10P
-------------------------------------	---------------------	-------------------------	-------------------

SP Newtron® LED with medium grey cord **F55525**

Cord F00633 Ø5x7 / Length 2300mm	Handpiece F12609	Potentiometer F00524	Tips 1S, 2, 10P
-------------------------------------	---------------------	-------------------------	--------------------

SP Newtron® LED with medium grey cord **F55501**

Cord F00633 Ø7x10 / Length 1900mm	Handpiece F12609	Potentiometer F00524	Tips 1, 2, 10P
--------------------------------------	---------------------	-------------------------	-------------------

SP Newtron® LED INTL 81" handpiece with medium grey cord **F55454**

Cord F00633 Ø5x7 / Length 1900mm	Handpiece F12609	Potentiometer F00525	Tips 1, 2, 10P
-------------------------------------	---------------------	-------------------------	-------------------

SP Newtron® LED with dark grey cord **F55507**

Cord F00618 Ø6x8 / Length 2300mm	Handpiece F12609	Potentiometer F00524	Tips 1, 2, 10P
-------------------------------------	---------------------	-------------------------	-------------------

SP Newtron® LED with dark grey cord **F55510**

Cord F00616 Ø5x7 / Length 1400mm	Handpiece F12609	Potentiometer F00524	Tips 1, 10Z, H3
-------------------------------------	---------------------	-------------------------	--------------------

SP Newtron® LED with dark grey cord **F55512**

Cord F01182 Ø5x7 / Length 2300mm	Handpiece F12609	Potentiometer F00524	Tips 1, 2, 10P
-------------------------------------	---------------------	-------------------------	-------------------

sp4055 newtron

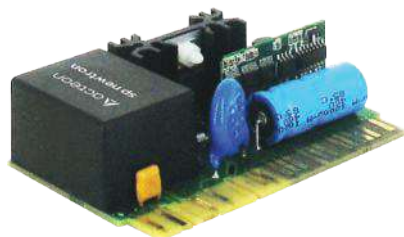

SP 4055 Newtron® Module

F55270

Class IIa medical device (GMED) - CE 0459 - Manufacturer: SATELEC® ACTEON® Group - France

SP 4055 Newtron® LED + driver with dark grey cord

F55377

Cord F00618	Handpiece	Tips
Ø6x8 / Length 2300mm	F12609	1, H3, 4x K15/21

SP 4055 Newtron® with light grey cord

F55240

Cord F00432	Handpiece	Potentiometer	Tips
Ø7x10 / Length 1900mm	F12281	F00524	1, 2, 10P

SP 4055 Newtron® with medium grey cord

F55410

Cord F00137	Handpiece	Potentiometer	Tips
Ø7x10 / Length 2300mm	F12281	F00524	1, 2, 10P

SP 4055 Newtron® with dark grey cord

F56268

Cord F01157	Handpiece	Tips
Ø6x8 / Length 2300mm	F12281	1, H3, 4x K15/21



xinetic



Xinetic Module

F55089

Class IIa medical device (GMED) - CE 0459 - Manufacturer: SATELEC® ACTEON® Group - France

Xinetic with light grey cord

F55090

Cord F00195	Handpiece	Potentiometer	Tips
Ø4x6 / Length 2070mm	F12200	F55088	1

Xinetic with medium grey cord

F55091

Cord F01154	Handpiece	Tips
Ø5x7 / Length 2070mm	F12200	1

Xinetic with light grey cord

F55100

Cord F00187	Handpiece	Potentiometer	Tips
Ø4x6 / Length 2300mm	F12200	F55088	1, H3



Standard cords

	Light grey silicone cord Ø4x6; L 2070cm	F00195
	Light grey silicone cord Ø6x8; L 2070cm	F00239
	Medium grey Newtron® cord 61" Ø5x7; L 1400cm	F01153
	Medium grey Newtron® cord 81" Ø5x7; L 1900cm	F01154
	Dark grey silicone cord Ø4x6; L 2300cm	F00150
	Dark grey silicone cord Ø4x6; L 2300cm	F00187
	Dark grey cord Ø7x10; L 1500cm	F00426
	Dark grey cord Ø6x8; L 2300cm	F01157
	Surf 6 grey Newtron® cord 61" Ø5x7; L 1400cm	F00184
	Surf 6 grey Newtron® cord 81" Ø5x7; L 1900cm	F00188
	Surf 6 grey silicone cord Ø6x8; L 2300cm	F00234

LED cords

	Light grey LED cord Ø5x7; L 2070cm	F00606
	Light grey Newtron® LED cord Ø6x8; L 2070cm	F00614
	Medium grey Fedesa cord Ø7x10; L 1900cm	F00607
	Medium grey Newtron® LED cord 81" Ø5x7; L 1900cm	F00633
	Dark grey Newtron® LED cord Ø6x8; L 2300cm	F00618
	Surf 6 grey LED cord Ø5x7; L 2300m	F01182
	Surf 6 grey LED cord Ø5x7 ; L 1400m	F00616
	Light grey Newtron® SLIM LED cord Ø4.5x5.6; L 2080cm	F01200
	Medium grey Newtron® SLIM LED cord Ø4.5x5.6; L 2080cm	F01201
	Dark grey Newtron® SLIM LED cord Ø4.5x5.6; L 2080cm	F01202

Handpieces

	Suprasson handpiece autoclavable, light grey	<i>F12200</i>
	Newtron® handpiece autoclavable, light grey/dark grey	<i>F12281</i>
	Newtron® titanium handpiece autoclavable, light grey/dark grey	<i>F01153</i>
	Newtron® LED handpiece autoclavable	<i>F12609</i>
	Newtron® LED titanium handpiece autoclavable	<i>F12689</i>
	Low voltage Newtron® LED handpiece autoclavable	<i>F12607</i>
	Newtron® SLIM handpiece without LED	<i>F12901</i>
	Low voltage Newtron® SLIM B.LED handpiece with white LED ring	<i>F12905</i>
	Newtron® SLIM B.LED handpiece with white LED ring 11V	<i>F12909</i>

LED rings

	LED ring for Newtron® LED handpiece	<i>F12605</i>
	LED ring - Low voltage for low voltage Newtron® LED handpiece	<i>F12606</i>
	Newtron® SLIM B.LED blue LED ring for low voltage Newtron® Slim B.LED handpiece	<i>F62201</i>
	Newtron® SLIM B.LED white LED ring for low voltage Newtron® Slim B.LED handpiece	<i>F12915</i>
	Newtron® SLIM B.LED white LED ring 11V - for Newtron® Slim B.LED handpiece	<i>F12932</i>
	Newtron® SLIM B.LED blue LED ring 11V - for Newtron® Slim B.LED handpiece	<i>F12934</i>

Accessories



Potentiometer 4.7K

F00522



Color SP Newtron® potentiometer 4.7K

F00524



Xinetic potentiometer

F55088



LUX handpiece SAV OEM Kit
to LED handpiece LUX
with low voltage LED handpiece, low
voltage LED ring, 2 resistances kit, light
grey LED handpiece OEM cord Ø5x7
(2.07m) and 3 o'rings seal + o'ring tool

F12686

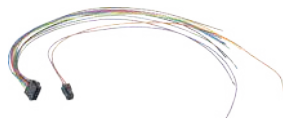

Wiring extension SP Newtron®

F55205



Wiring extension SP Newtron® led

F55522

SP Newtron® dummy load

F12901



SteriPump kit without module
with 2 autoclavable irrigation lines and 10
perforators

F28653



SteriPump module

F28660



SteriPump + module Kit
with a Steri Pump, Steri Pump module,
2 autoclavable irrigation lines and
10 perforators

F28652



Complete SteriPump kit
Delivered with a Steri Pump, Steri
Pump module, 2 autoclavable irrigation
lines and 10 perforators, 5 clips, a 4.7K
potentiometer

F28650

MOTORS

.....



Modules



M6 module
without option

F34300



M6P module
Pneumatic option with connectors

F34304

Motors



Light motor

F28600



AV40 motor
External spray

F28502

Cords



Medium grey cord
for light and IS motors

F33711



Medium grey cord
for AV motor

F33712



Black coiled cord
for light motor

F33713

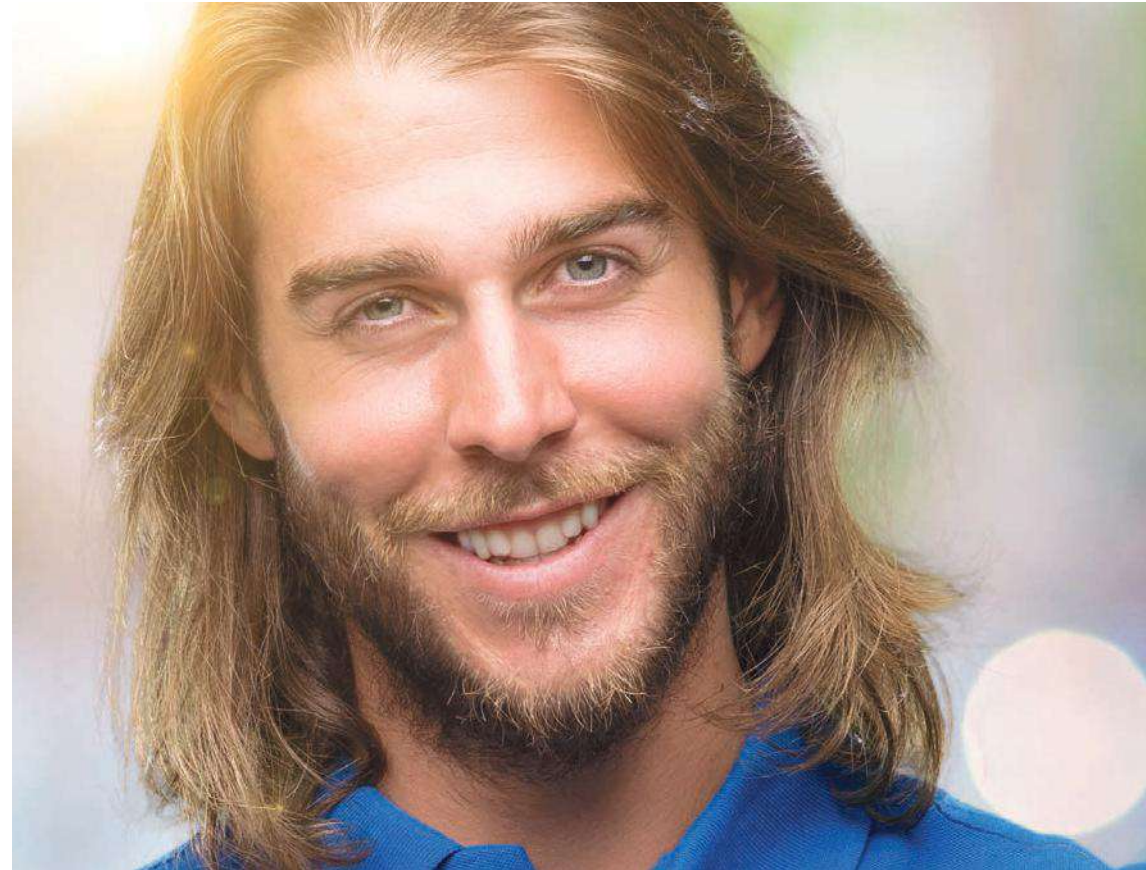

CURING LIGHT

.....



miniled standard



MiniLED™ OEM handpiece

F02710

MiniLED™ OEM with module

with a handpiece, a module, a Ø7.5mm opalescent guide, an oval light shield and with:

Surf 6 grey cord	F02505
Medium grey cord	F02719
Dark grey cord	F02720
Gray 3 (Medium grey) cord	F02538

MiniLED™ OEM with module

with a handpiece, a module, a Ø7.5mm opalescent guide, 2 caps and with:
Light grey cord

F02715

MiniLED™ OEM without module

with a handpiece, a Ø7.5mm opalescent guide, an oval light shield and with:
Medium grey cord
Dark grey cord

F02693

F02694

MiniLED™ OEM without module

with a handpiece, a module, a Ø7.5mm opalescent guide, an oval light shield and with:

Light grey cord	F02714
-----------------	---------------



Light grey

Medium grey

Dark grey

miniled supercharged



MiniLED™ Supercharged OEM handpiece

F05218

MiniLED™ Supercharged OEM with module

with a handpiece, a module, a Ø7.5mm opalescent guide, an oval light shield and with:

Light grey cord	F05205
Medium grey cord	F05206
Dark grey cord	F05207
Surf 6 grey cord	F05208



Light grey

Medium grey

Dark grey

Modules



MiniLED™ OEM module

F02730

Cords



Dark grey cord

F02721



Medium grey cord

F02722



Light grey cord

F02723

Surf 6 grey cord

F02326

Grey 3 (Medium grey) cord

F02327

Light guides



Opalescent light guide Ø7.5mm

F02648



Opalescent light guide Ø5.5mm

F02652



Opalescent amber light guide Ø5.5mm

F02620



Opalescent light guide Ø7.5mm
Scanwave

F02648



Opalescent light guide Ø5.5mm
Scanwave

F02652

Light shield & caps



Oval light shield
for MiniLED™ Supercharged OEM

F05407



Oval light shield
for MiniLED™ OEM

F02555



Autoclavable caps Ø7.5mm x5
for MiniLED™ OEM,
MiniLED™ Supercharged OEM

F61507



Autoclavable caps Ø5.5mm x5
for MiniLED™ OEM,
MiniLED™ Supercharged OEM

F61505



Autoclavable caps Ø7.5mm x5
Autoclavable caps Ø5.5mm x5
for MiniLED™ OEM,
MiniLED™ Supercharged OEM

F61515

INTRAORAL CAMERAS

.....



Module & linking cables dock U



Mini Dock U USB2⁽¹⁾
Built-in docking station with USB2 output

**MINI DOCK
U_USB2**

Linking cables for built-in docking stations type U without sheath Length 2.5m	922144
Linking cables for built-in docking stations type U without sheath Length 5m	922145
Linking cables for built-in docking stations type U without sheath Length 7m	922146
Linking cables for built-in docking stations type MU without sheath Length 2.5m	922062
Linking cables for built-in docking stations type MU without sheath Length 5m	922063
Linking cables for built-in docking stations type MU without sheath Length 7m	922064

(1) Mini Dock U USB2 : Built-in docking station with USB2 output.
Class I medical devices - CE - Manufacturer: Sopro ACTEON® Group - France

Linking cables dock U

Linking cable light grey instrument holder Length 2.5m	922147
Linking cable light grey instrument holder Length 5m	922148
Linking cable light grey instrument holder Length 7m	922149
Linking cable light grey Cattani Ø21 suction holder Length 5m	922150
Linking cable light grey UK pending cord holder Length 2.5m	922151
Linking cable light grey UK pending cord holder Length 5m	922152
Linking cable light grey UK pending cord holder Length 7m	922153
Linking cable Surf 6 instrument holder Length 2.5m	922154
Linking cable Surf 6 instrument holder Length 5m	922155
Linking cable Surf 6 instrument holder Length 7m	922156
Linking cable Surf 6 Cattani Ø21 suction holder Length 2.5m	922157
Linking cable Surf 6 Cattani Ø21 suction holder Length 5m	922158
Linking cable Surf 6 Cattani Ø21 suction holder Length 7m	922159
Linking cable Surf 6 UK pending cord holder Length 2.5m	922138
Linking cable Surf 6 UK pending cord holder Length 5mWw	922160
Linking cable Surf 6 UK pending cord holder Length 7m	922139

Linking cables dock U

Linking cable grey 3 UK pending cord holder Length 2m	922140
Linking cable grey 3 UK pending cord holder Length 7m	922141
Linking cable dark grey instrument holder Length 2.5m	922161
Linking cable dark grey instrument holder Length 5m	922162
Linking cable dark grey instrument holder Length 7m	922163
Linking cable dark grey Cattani Ø21 suction holder Length 2.5m	922164
Linking cable dark grey Cattani Ø21 suction holder Length 5m	922165
Linking cable dark grey UK pending cord holder Length 7m	922166
Linking cable medium grey instrument holder Length 2.5m	922167
Linking cable medium grey instrument holder Length 5m	922168
Linking cable medium grey instrument holder Length 7m	922143
Linking cable medium grey Cattani Ø21 suction holder Length 5m	922142

Configuration of docks U

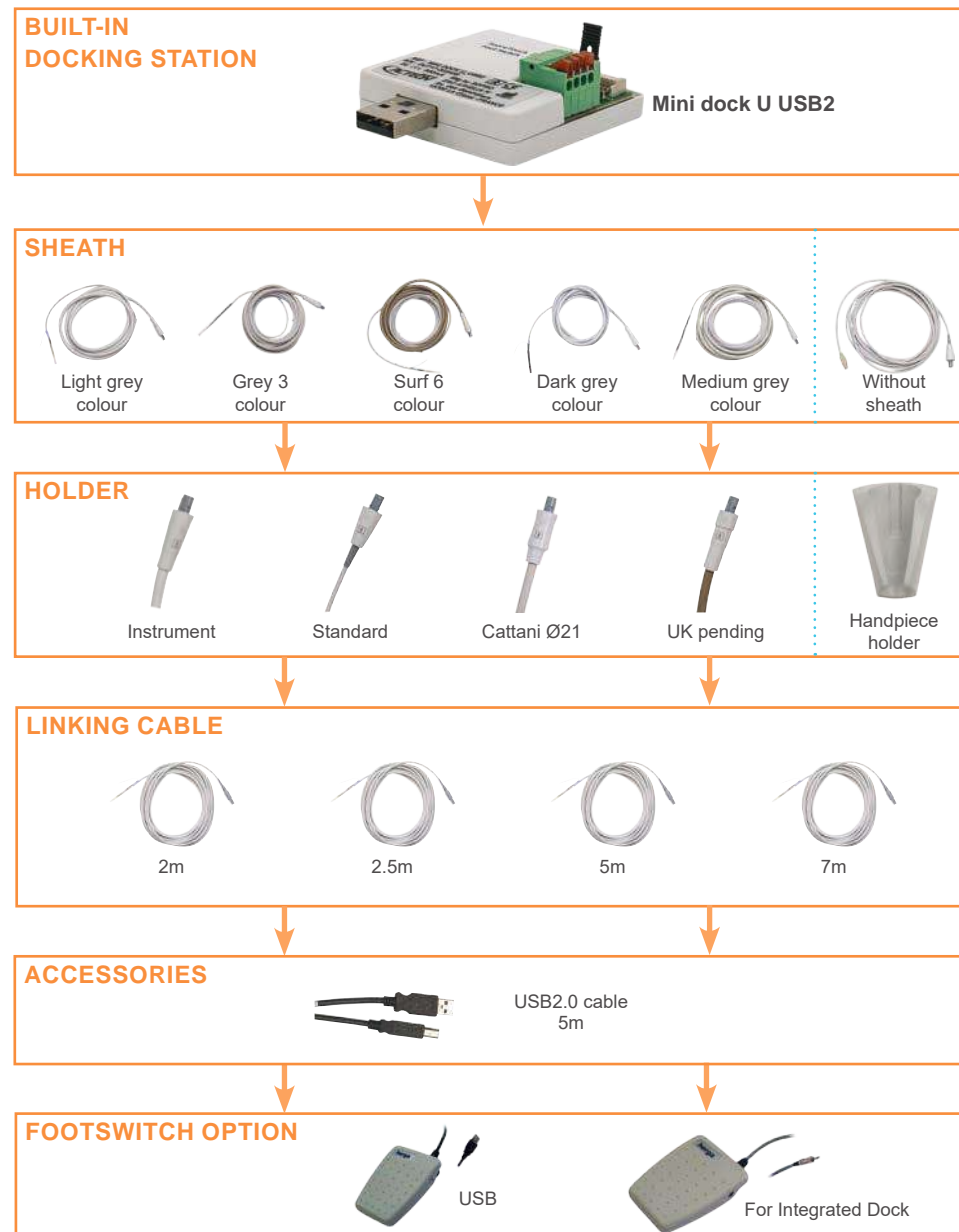

Linking cables dock MU USB2

Linking cable light grey instrument holder Length 2.5m	922065
Linking cable light grey instrument holder Length 5m	922066
Linking cable light grey instrument holder Length 7m	922067
Linking cable light grey Cattani Ø21 suction holder Length 5m	922075
Linking cable light grey UK pending cord holder Length 2.5m	922086
Linking cable light grey UK pending cord holder Length 5m	922087
Linking cable light grey UK pending cord holder Length 7m	922088
Linking cable Surf 6 instrument holder Length 2.5m	922098
Linking cable Surf 6 instrument holder Length 5m	922099
Linking cable Surf 6 instrument holder Length 7m	922100
Linking cable Surf 6 Cattani Ø21 suction holder Length 2.5m	922101
Linking cable Surf 6 Cattani Ø21 suction holder Length 5m	922102
Linking cable Surf 6 Cattani Ø21 suction holder Length 7m	922103
Linking cable Surf 6 UK pending cord holder Length 2.5m	922104
Linking cable Surf 6 UK pending cord holder Length 5mWw	922105
Linking cable Surf 6 UK pending cord holder Length 7m	922106

Linking cable grey 3 UK pending cord holder Length 2m	922106
Linking cable grey 3 UK pending cord holder Length 7m	922127
Linking cable dark grey instrument holder Length 2.5m	922068
Linking cable dark grey instrument holder Length 5m	922069
Linking cable dark grey instrument holder Length 7m	922070
Linking cable dark grey Cattani Ø21 suction holder Length 2.5m	922080
Linking cable dark grey Cattani Ø21 suction holder Length 5m	922081
Linking cable dark grey UK pending cord holder Length 7m	922094
Linking cable medium grey instrument holder Length 2.5m	922071
Linking cable medium grey instrument holder Length 5m	922072
Linking cable medium grey instrument holder Length 7m	922073
Linking cable medium grey Cattani Ø21 suction holder Length 5m	922084



ACTEON®
Via Roma 53,
21057 Olgiate Olona (VA)
ITALIA

Tel: +39 0331 376760
Fax: +39 0331 376763
info.it@acteongroup.com

Follow-us

